

TIBOX[®]
TIANQI ELECTRIC



TIBOX[®]
TIANQI ELECTRIC



***NO.1 professional manufacturer
of boxes-China***

About us

WE with 17 years experience in electrical industry, is one of the leading manufacturers of distribution boxes in China. Founded in China 1998, located in the beautiful land scape of the largest China Bamboo Sea is in the north of Zhejiang province, covers an area of 66,000 square metres and has 400 employees. The company has got the national quality system certificate of ISO9001 and also received warm welcome in its circle. Our ISO 9001:2758 and ISO 14001:2754-certificated factory is equipped with seven production lines, which allow us to supply up to 60,000 pieces every month. The company also got OHSAS 18001:2007 of occupational health and safety management systems.

We offer 400 different products for our clients to choose from. And our engineers add 5 to 10 new items to this variety every year. We can also develop a new product according to your special requests within 40 days.

Our trained staff work on imported production equipment, and we have over 20QC personnel to strictly inspect our products, which carry CE and ROHS marks, and are SGS-and TUV-inspected and UL approved. We export to buyers in the US, Canada, South America, southeast Asia, the Middle East, India, Africa and other countries and regions. For delivery, you can expect to get your order in 30 to 60 days, depending upon the quantity. **E-mail us today.**

CONFORMITY AND APPROVAL

ISO9001   IP66   



RAL7032



RAL7035



RAL3000



RAL5015

NOTE: Printing error to standard color RAL

Company headquarters



Company headquarters



Company headquarters



Polyester enclosure



CE RoHS IP65

Polyester enclosure

Material: fiberglass/ SMC, self-extinguishable or UV material are on request

Color: RAL7035

Protection degree: IP65

Working temperature: -40°C to +120°C

Mechanical impact: IK08

Supply include:

door with lock system, enclosure, wall mount brackets 4pcs/set.

Mounting plate to be supplied separately as to the clients request

Resistance against rusting and corrosion by chemical or atmospherical condition

Easy to machine/easy to move around and install because of its lightness.

Door hinges allows more than 180° opening.

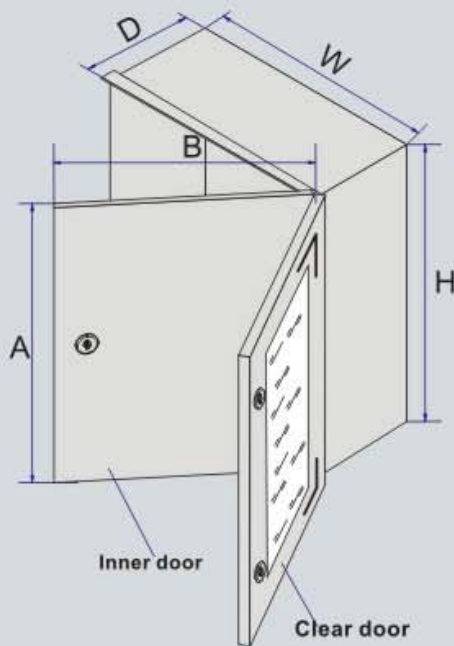

Standard lock
model: MS-01
package: 1pc



Key lock
model: MS705-3E
package: 1pc



Wall mount brackets
model: TXP-01 package: 4pcs/set

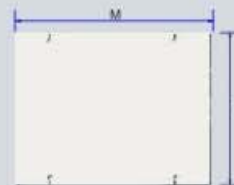

Polyester mounting plate



Galvanised mounting plate

Polyester box(fiber glass box,GRP box)			Inner door for polyester box			Polyester mounting plate		Galvanised mounting plate					
Model		Dimension(mm)			Model metal Inner door		Dimension(mm)		Model Dimension(mm)				
Grey door	Clear door	W	H	D	A	B	M	N	C	E			
TIP-325	TX-325	250	300	140	\	\	PP-325	221	238	TI-325	263	201	
TIP-43	TX-43	300	400	200	TP-43	364	245	PP-43	311	286	TI-43	353	245
TIP-44	TX-44	400	400	200	TP-44	364	345	PP-44	308	386	TI-44	349	345
TIP-54	TX-54	400	500	200	TP-54	464	345	PP-54	408	386	TI-54	453	345
TIP-64	TX-64	400	600	230	TP-64	564	345	PP-64	511	386	TI-64	553	345
TIP-65	TX-65	500	600	230	TP-65	564	445	PP-65	508	486	TI-65	553	447
TIP-86	TX-86	600	800	300	TP-86	764	545	PP-86	706	581	TI-86	749	540



Aluminum enclosure



LV aluminium boxes are suitable for installation, circuit breaking, connection and control of electric and electronic equipments, and find their main application in Industrial, automotive, railways, navy, tunnels, parkings, industrial buildings fields ensuring a high mechanical and vibration resistance with IP66 protection degree.

Standard Supply:
 Aluminum box PUR seal stainless steel screws, M4 screws
 Specification:
 Material: ALSI 12 DINI 725 standard
 Protection degree: IP66 EN60529 standard
 Resistance to Impact: >7 Joule EN50014 standard
 Temperature range: -50°C to 130°C
 Paint Finish: epoxy polyester powder coating
 Color: RAL7001

Aluminum enclosure

MODEL	W X H X D (mm)
LV0605	64×58×36
LV1106	115×65×55
LV1106-1	110×65×37
LV0807	80×75×59
LV1208	120×80×55
LV1208-1	120×80×55
LV1308	135×85×67
LV1708	174×80×58
LV2508	250×80×65
LV2508-1	250×80×80
LV1409	148×98×43

MODEL	W X H X D (mm)
LV1610	160×100×60
LV1212	120×120×80
LV1812	188×120×80
LV1414	140×140×75
LV2214	220×146×60
LV2214-1	220×146×77
LV2214-2	220×147×80
LV2315	230×150×73
LV1616	160×160×90
LV1616-1	160×160×70
LV2616	260×160×90

MODEL	W X H X D (mm)
LV2416-1	240×160×100
LV1418	140×180×62
LV2618	265×185×95
LV2619	265×190×130
LV3021	300×210×130
LV2823	280×230×110
LV3423	340×230×95
LV3323-1	330×230×120
LV3423-2	340×230×135
LV3423-3	340×230×160
LV1925	190×250×92

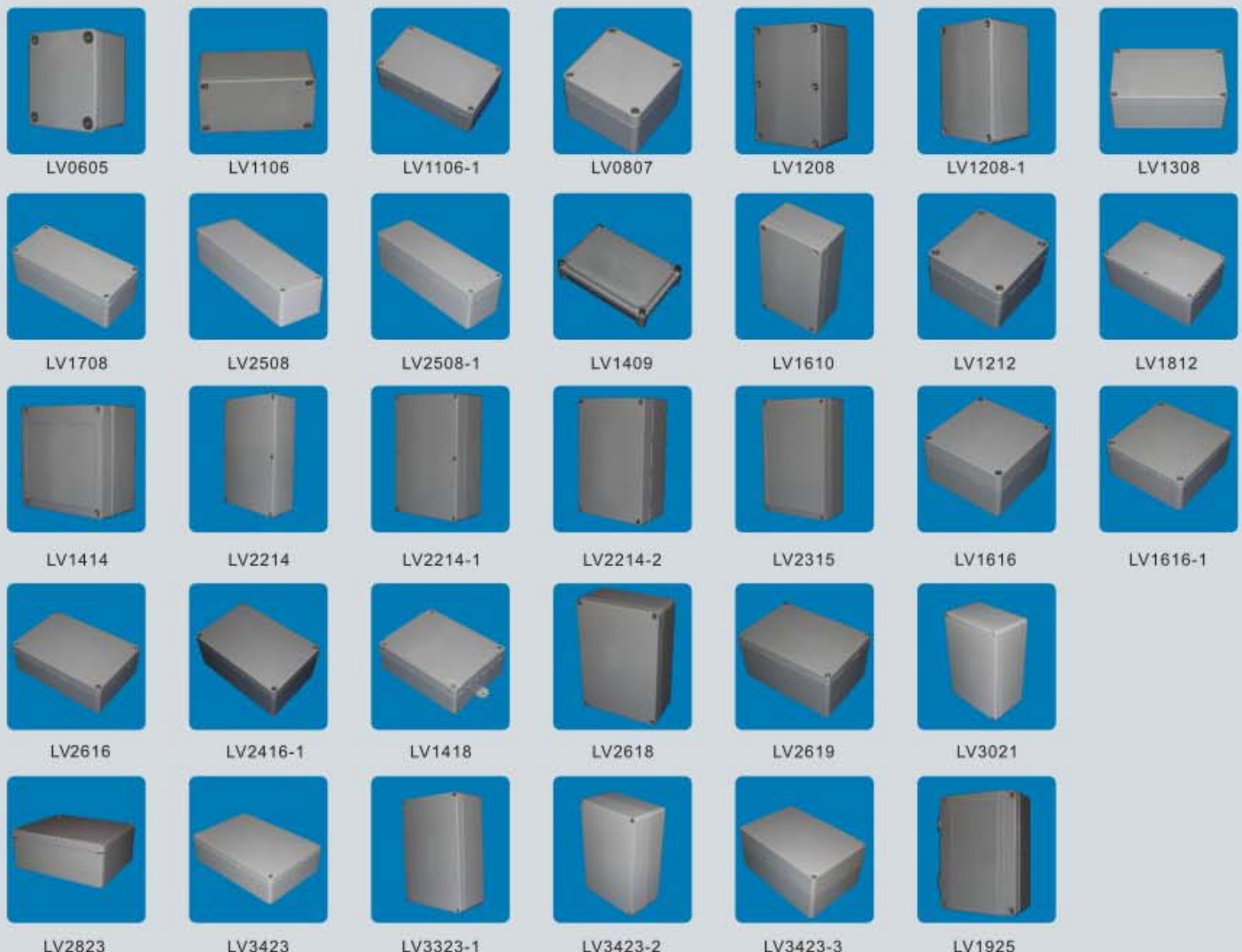

Plastic enclosure

Plastic enclosure-switch box

The enclosure is about 25% the weight of a metal box and can be easily installed or moved. The products are free from corrosion, carries superior insulation. The enclosure are available for the installation of terminal substitution rail, button box, small terminal, signal, relay and sensor, communication and joint box. It will not be damaged even using for a long time because stainless hinge and draw latch are equipped. It secures perfect airtightness by preventing sink down when opening or closing the sizes of hinge and draw latch by size increasing of the products. It can be used in inferior or dangerous industrial field by using strong material and structure
 Temperature range: -40°C to +120°C ABS: Acrylonitrile Butadiene Styrene PC: Poly Carbonate



Screw type- Switch box



Stainless steel latch+screw type

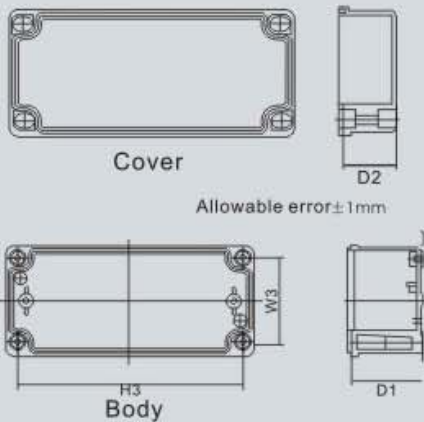

Screw type		Stainless steel latch +screw type		Dimension(mm)		Mounting plate		Installation size(mm)	
Grey door	Clear door	Grey door	Clear door	W X H X D	D1+D2	Plastic	Metal	W3	H3
TJ-AG-0506	TJ-AT-0506	TJ-AGH-0506	TJ-ATH-0506	50×65×55	40+15	/	TJ-0506	37	52
TJ-AG-0609	TJ-AT-0609	TJ-AGH-0609	TJ-ATH-0609	65×95×55	35+20	/	/	50	79
TJ-AG-0712	TJ-AT-0712	TJ-AGH-0712	TJ-ATH-0712	75×125×75	50+25	TJ-0712P	TJ-0712	56	107
TJ-AG-0712-1	TJ-AT-0712-1	TJ-AGH-0712-1	TJ-ATH-0712-1	75×125×100	50+50	TJ-0712P	TJ-0712	56	107
TJ-AG-0808	TJ-AT-0808	TJ-AGH-0808	TJ-ATH-0808	80×80×60	45+15	/	TJ-0808	62	62
TJ-AG-0811-S	TJ-AT-0811-S	TJ-AGH-0811-S	TJ-ATH-0811-S	80×110×45	25+35	TJ-0811P	TJ-0811	62	92
TJ-AG-0811-1S	TJ-AT-0811-1S	TJ-AGH-0811-1S	TJ-ATH-0811-1S	80×110×60	35+25	TJ-0811P	TJ-0811	62	92
TJ-AG-0811	TJ-AT-0811	TJ-AGH-0811	TJ-ATH-0811	80×110×70	50+20	TJ-0811P	TJ-0811	62	92
TJ-AG-0811-1	TJ-AT-0811-1	TJ-AGH-0811-1	TJ-ATH-0811-1	80×110×85	50+35	TJ-0811P	TJ-0811	62	92
TJ-AG-0813	TJ-AT-0813	TJ-AGH-0813	TJ-ATH-0813	80×130×70	50+20	TJ-0813P	TJ-0813	62	112
TJ-AG-0813-1	TJ-AT-0813-1	TJ-AGH-0813-1	TJ-ATH-0813-1	80×130×85	50+35	TJ-0813P	TJ-0813	62	112
TJ-AG-0816-S	TJ-AT-0816-S	TJ-AGH-0816-S	TJ-ATH-0816-S	80×160×55	40+15	TJ-0816P	TJ-0816	68	148
TJ-AG-0816	TJ-AT-0816	TJ-AGH-0816	TJ-ATH-0816	80×160×90	75+15	TJ-0816P	TJ-0816	68	148
TJ-AG-0818	TJ-AT-0818	TJ-AGH-0818	TJ-ATH-0818	80×180×70	50+20	TJ-0818P	TJ-0818	62	162
TJ-AG-0818-1	TJ-AT-0818-1	TJ-AGH-0818-1	TJ-ATH-0818-1	80×180×85	50+35	TJ-0818P	TJ-0818	62	162
TJ-AG-0825	TJ-AT-0825	TJ-AGH-0825	TJ-ATH-0825	80×250×70	50+20	TJ-0825P	TJ-0825	62	232
TJ-AG-0825-1	TJ-AT-0825-1	TJ-AGH-0825-1	TJ-ATH-0825-1	80×250×85	50+35	TJ-0825P	TJ-0825	62	232
TJ-AG-1010	TJ-AT-1010	TJ-AGH-1010	TJ-ATH-1010	100×100×75	55+20	/	TJ-1010	75	82
TJ-AG-1018	TJ-AT-1018	TJ-AGH-1018	TJ-ATH-1018	180×100×75	60+15	/	TJ-1018	75	155
TJ-AG-1022	TJ-AT-1022	TJ-AGH-1022	TJ-ATH-1022	223×100×75	60+15	/	TJ-1022	75	198
TJ-AG-1212-S	TJ-AT-1212-S	TJ-AGH-1212-S	TJ-ATH-1212-S	125×125×75	55+20	TJ-1212P	TJ-1212	105	105
TJ-AG-1212	TJ-AT-1212	TJ-AGH-1212	TJ-ATH-1212	125×125×100	80+20	TJ-1212P	TJ-1212	105	105
TJ-AG-1217	TJ-AT-1217	TJ-AGH-1217	TJ-ATH-1217	125×175×75	50+25	TJ-1217P	TJ-1217	108	156
TJ-AG-1217-1	TJ-AT-1217-1	TJ-AGH-1217-1	TJ-ATH-1217-1	125×175×100	50+50	TJ-1217P	TJ-1217	108	156
TJ-AG-1220	TJ-AT-1220	TJ-AGH-1220	TJ-ATH-1220	200×120×75	60+15	/	TJ-1220	102	182
TJ-AG-1417	TJ-AT-1417	TJ-AGH-1417	TJ-ATH-1417	140×170×95	75+20	TJ-1417P	TJ-1417	122	152
TJ-AG-1423	TJ-AT-1423	TJ-AGH-1423	TJ-ATH-1423	140×230×90	70+20	TJ-1423P	TJ-1423	121	211
TJ-AG-1520-S	TJ-AT-1520-S	TJ-AGH-1520-S	TJ-ATH-1520-S	150×200×75	50+25	TJ-1520P	TJ-1520	131	182
TJ-AG-1520	TJ-AT-1520	TJ-AGH-1520	TJ-ATH-1520	150×200×100	80+20	TJ-1520P	TJ-1520	131	182
TJ-AG-1520-1	TJ-AT-1520-1	TJ-AGH-1520-1	TJ-ATH-1520-1	150×200×130	80+50	TJ-1520P	TJ-1520	131	182
TJ-AG-1525	TJ-AT-1525	TJ-AGH-1525	TJ-ATH-1525	150×250×100	80+20	TJ-1525P	TJ-1525	132	232
TJ-AG-1525-1	TJ-AT-1525-1	TJ-AGH-1525-1	TJ-ATH-1525-1	150×250×130	80+50	TJ-1525P	TJ-1525	132	232
TJ-AG-1717	TJ-AT-1717	TJ-AGH-1717	TJ-ATH-1717	175×175×75	50+25	TJ-1717P	TJ-1717	155	155
TJ-AG-1717-1	TJ-AT-1717-1	TJ-AGH-1717-1	TJ-ATH-1717-1	175×175×100	50+50	TJ-1717P	TJ-1717	155	155
TJ-AG-1725	TJ-AT-1725	TJ-AGH-1725	TJ-ATH-1725	175×250×75	50+25	TJ-1725P	TJ-1725	157	232
TJ-AG-1725-1	TJ-AT-1725-1	TJ-AGH-1725-1	TJ-ATH-1725-1	175×250×100	50+50	TJ-1725P	TJ-1725	157	232
TJ-AG-2020-S	TJ-AT-2020-S	TJ-AGH-2020-S	TJ-ATH-2020-S	200×200×95	75+20	TJ-2020P	TJ-2020	182	182
TJ-AG-2020	TJ-AT-2020	TJ-AGH-2020	TJ-ATH-2020	200×200×130	110+20	TJ-2020P	TJ-2020	182	182
TJ-AG-2025	TJ-AT-2025	TJ-AGH-2025	TJ-ATH-2025	250×200×100	75+25	/	TJ-2025	178	223

Plastic enclosure-big switch box

The enclosure is according to EN60529 standard, free from corrosion, compressive property and installation, widely used in electronics, communications, fire fighting apparatus, control panels, terminal boxes, public accommodation, ship industry, food industry etc. We always give top priority to quality and safety, your satisfaction is guaranteed.

Temperature range: -40°C to +120°C
 ABS: Acrylonitrile Butadiene Styrene
 PC: Poly Carbonate



Plastic enclosure- big switch box

Screw type		Stainless steel latch +screw type		Dimension(mm)		Mounting plate		Installation size(mm)	
Grey door	Clear door	Grey door	Clear door	W X H X D	D1+D2	Plastic	Metal	W3	H3
TJ-AG-2819	TJ-AT-2819	TJ-AGH-2819	TJ-ATH-2819	280×190×130	100+30	TJ-2819P	TJ-2819	165	255
TJ-AG-2819-1	TJ-AT-2819-1	TJ-AGH-2819-1	TJ-ATH-2819-1	280×190×180	100+80	TJ-2819P	TJ-2819	165	255
TJ-AG-2828	TJ-AT-2828	TJ-AGH-2828	TJ-ATH-2828	280×280×130	100+30	TJ-2828P	TJ-2828	255	255
TJ-AG-2828-1	TJ-AT-2828-1	TJ-AGH-2828-1	TJ-ATH-2828-1	280×280×180	100+80	TJ-3428P	TJ-3428	255	255
TJ-AG-3428	TJ-AT-3428	TJ-AGH-3428	TJ-ATH-3428	340×280×130	100+30	TJ-3428P	TJ-3428	315	255
TJ-AG-3819-S	TJ-AT-3819-S	TJ-AGH-3819-S	TJ-ATH-3819-S	380×190×100	70+30	/	TJ-3819	165	355
TJ-AG-3819	TJ-AT-3819	TJ-AGH-3819	TJ-ATH-3819	380×190×130	100+30	/	TJ-3819	165	355
TJ-AG-3819-1	TJ-AT-3819-1	TJ-AGH-3819-1	TJ-ATH-3819-1	380×190×180	150+30	/	TJ-3819	165	355
TJ-AG-3428-1	TJ-AT-3428-1	TJ-AGH-3428-1	TJ-ATH-3428-1	340×280×180	100+80	TJ-3828P	TJ-3828	315	255
TJ-AG-3828	TJ-AT-3828	TJ-AGH-3828	TJ-ATH-3828	380×280×130	100+30	TJ-3828P	TJ-3828	355	255
TJ-AG-3828-1	TJ-AT-3828-1	TJ-AGH-3828-1	TJ-ATH-3828-1	380×280×180	100+80	TJ-2828P	TJ-2828	355	255
TJ-AG-3856	TJ-AT-3856	TJ-AGH-3856	TJ-ATH-3856	560×380×180	150+30	/	TJ-3856	354	534



Plastic enclosure

Plastic enclosure - screw type

Out of the plastic boxes which are selling at present, it's ability and working efficiency, the competitive power is much higher with the low price same as the level of steel box. The products were added the electromagnetic interference(EMI) and prevent substance of the static electricity, and the strong point was given to the relevant mechanical protection of electricity, electron and etc. The users are possible according to the size such as small terminal box, signal, terminal and push button, control box etc.

Temperature range:-40°C to +120°C ABS:Acrylonitrile Butadiene Styrene PC:Poly Carbamate



Plastic enclosure - screw type

Screw type		Dimension(mm)		Metal Mounting plate		Installation size(mm)	
Grey door	Clear door	W X H X D	D1+D2			W3	H3
TB-AG-0812	TB-AT-0812	80×120×50	40 + 14	TJ-0812		88	88
TB-AG-1010	TB-AT-1010	100×100×50	40 + 14	TJ-1010		68	108
TB-AG-1115	TB-AT-1115	110×150×70	49 + 25	TJ-1115		98	137
TB-AG-1419	TB-AT-1419	140×190×70	51 + 25	TJ-1419		128	177
TB-AG-1924	TB-AT-1924	190×240×90	70 + 26	TJ-1924		170	226
TB-AG-1924-1	TB-AT-1924-1	190×240×160	70 + 96	TJ-1924-1		170	226
TB-AG-2230	TB-AT-2230	220×300×120	76 + 50	TJ-2230		200	280
TB-AG-3038	TB-AT-3038	300×380×120	78 + 50	TJ-3038		281	278

Plastic enclosure-lock+hinge type

Beautiful appearance,excellent processing and stability should be guaranteed by material such as high intensity ABS and PC with standing harsh industrial and outdoor environments. Available with 3mm double locks,the other side is hinges,weight of the metal box ,easy for handling and operation. Standard unit include cabinet base,door with gasket ,locks,hinges,back panel mounting screws.

The product is waterproof and dustproof, adequate for small terminal boxes,singal box,relay,calculator,junction box etc.

Temperature range:-40°C to +120°C ABS:Acrylonitrile Butadiene Styrene PC:Poly Carbamate



Plastic enclosure - lock+ hinge type

Lock+hinge type		Dimension(mm)		Mounting plate		Installation size(mm)	
Grey door	Clear door	W X H X D	D1+D2	Plastic	Metal	W3	H3
TJ-KG-2030	TJ-KT-2030	200×300×180	130 + 50	TJ-2030P	TJ-2030	171	271
TJ-KG-3030	TJ-KT-3030	300×300×180	130 + 50	TJ-3030P	TJ-3030	269	269
TJ-KG-4030	TJ-KT-4030	400×300×180	130 + 50	/	TJ-4030	270	370
TJ-KG-4050	TJ-KT-4050	400×500×200	150 + 50	/	TJ-4050	371	471
TJ-KG-4060	TJ-KT-4060	400×600×220	170 + 50	/	TJ-4060	370	570

NEW
NEW

Plastic enclosure-plastic latch+hinge type

Beautiful appearance,excellent processing and stability should be guaranteed by material such as high intensity ABS and PC with standing harsh industrial and outdoor environments. Available with plastic latch,the other side is hinges,weight of the metal box ,easy for handling and operation. Standard unit include cabinet base,door with gasket plastic latch, ,hinges,back panel mounting screws.

The product is waterproof and dustproof, adequate for small terminal boxes,singal box,relay,calculator,junction box etc.

Temperature range:-40°C to +120°C ABS:Acrylonitrile Butadiene Styrene PC:Poly Carbamate



Plastic enclosure-plastic latch+hinge type

Plastic latch+hinge type		Dimension(mm)		Mounting plate		Installation size(mm)	
Grey door	Clear door	W X H X D	D1+D2	Plastic	Metal	W3	H3
TJ-MG-2030	TJ-MT-2030	200×300×180	130 + 50	TJ-2030P	TJ-2030	171	271
TJ-MG-3030	TJ-MT-3030	300×300×180	130 + 50	/	TJ-3030	269	269
TJ-MG-3040	TJ-MT-3040	300×400×180	130 + 50	/	TJ-3040	270	370
TJ-MG-4030	TJ-MT-4030	400×300×180	130 + 50	/	TJ-4030	370	270
TJ-MG-4050	TJ-MT-4050	400×500×200	150 + 50	/	TJ-4050	371	471
TJ-MG-4060	TJ-MT-4060	400×600×220	170 + 50	/	TJ-4060	370	570

NEW
NEW

Stainless steel latch+hinge

Grey door	Clear door	W X H X D	D1+D2	Plastic	Metal	W3	H3
TJ-MG-2030-S	TJ-MT-2030-S	200×300×150	120+30	TJ-2030P	TJ-2030	171	271

Plastic enclosure

Accessories of plastic enclosure

Plastic enclosure-plastic latch+hinge type

Out of the plastic boxes which are selling at present, it's ability and working efficiency, the competitive power is much higher with the low price same as the level of steel box. The products were added the electromagnetic interference(EMI) and prevent substance of the static electricity, and the strong point was given to the relevant mechanical protection of electricity, electron and etc. The users are possible according to the size such as small terminal box, signal, terminal and push button, control box etc.

Temperature range:-40℃ to +120℃ ABS:Acrlonitrile Butadiene Styrene PC:Poly Carbnte



Plastic latch+hinge type

Plastic latch+hinge type		Dimension(mm)		Mounting plate		installation size(mm)	
Grey door	Clear door	W X H X D	D1+D2	Plastic	Metal	W3	H3
TE-AG-1015	TE-AT-1015	100×150×70	50 + 20	TJ-1015P	TJ-1015	66	116
TE-AG-1020	TE-AT-1020	100×200×70	50 + 20	TJ-1020P	TJ-1020	65	165
TE-AG-1515	TE-AT-1515	150×150×90	70 + 20	TJ-1515P	TJ-1515	115	120
TE-AG-1722	TE-AT-1722	170×220×110	80 + 30	TJ-1722P	TJ-1722	136	186
TE-AG-1929	TE-AT-1929	190×290×140	110 + 30	TJ-1929P	TJ-1929	156	254
TE-AG-2530	TE-AT-2530	300×250×150	110 + 40	TJ-2530P	TJ-2530	231	221
TE-AG-2535	TE-AT-2535	350×250×180	140 + 40	TJ-2535P	TJ-2535	281	321
TE-AG-2939	TE-AT-2939	290×390×160	132 + 28	TJ-2939P	TJ-2939	251	361

NEW
NEW

Plastic enclosure-SMC+PC type



SMC+PC type

Out of the plastic boxes which are selling at present, it's ability and working efficiency, the competitive power is much higher with the low price same as the level of steel box. The products were added the electromagnetic interference(EMI) and prevent substance of the static electricity, and the strong point was given to the relevant mechanical protection of electricity, electron and etc.

Temperature range:-40℃ to +120℃ SMC:Fiber glass(body) PC:Poly Carbnte(cover)

Grey door	Clear door	W X H X D	D1+D2	Plastic	Metal	W3	H3
PSG-3627	PST-3627	270×360×170	125+45	/	TJ-3627	245	335

NEW

Accessories of plastic enclosure



MODEL: MG
Wall brackets for big switch box
Material: nylon
Packing: 4pcs/set



MODEL: WP-01
S.S Wall brackets
Material: AISI 304
Packing: 4pcs/set



MODEL: WP-02
S.S Wall brackets
Material: AISI 304
Packing: 4pcs/set



MODEL: HG-02
Stainless steel hinge
Material: AISI304
Packing: 1pcs/set



MODEL: HG-01
Stainless steel hinge
Material: AISI304
Packing: 1pcs/set

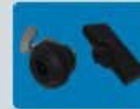

MODEL: MS-01
Standard lock of TJ-KG box
package: 1pc



MODEL: LC-01
Stainless steel latch
Material: AISI304
Packing: 1pcs/set



MODEL: LC-02
Stainless steel latch
Material: AISI304
Packing: 1pcs/set

PG electric cable gland



Model	PG7	PG9	PG11	PG13.5	PG16	PG21	PG29	PG36	PG42	PG48	PG63
Diameter(mm)	3-6.5	4-8	5-10	6-12	10-14	13-18	18-25	22-32	30-33	34-44	42-50
Screw length(mm)	8	8	8	9	10	11	11	13	13	13	27

Cable gland-brass nickel plated



Model	PG7	PG7	PG9	PG9	PG11	PG11	PG13.5	PG13.5	PG16	PG16	PG19	PG21
Diameter(mm)	3-6.5	2-5	4-8	2-6	5-10	3-7	6-12	5-9	10-14	6-12	10-14	13-18
GL(mm)	7	7	8	8	8	8	8	8	9	9	9	9
GL+(mm)	10	10	10	10	10	10	15	15	15	15	15	15

Model	PG21	PG25	PG29	PG29	PG36	PG36	PG42	PG42	PG48	PG48	PG63
Diameter(mm)	9-16	15-22	18-25	13-20	22-33	20-26	32-38	25-31	37-44	29-35	42-52
GL(mm)	9	10	11	11	13	13	14	14	15	15	15
GL+(mm)	15	15	15	15	15	15	20	20	20	20	20



Terminal block

Plastic terminal block box - junction box

Plastic terminal block box - junction box

The terminal block box, it is made by ABS material, Normal voltage: 400V The normal current capacity: 0.75mm sq.-15mm sq.
 Temperature range: -40°C to +120°C ABS: Acrylonitrile Butadiene Styrene PC: Poly Carbamate
 Product with hole can be used without separate processing

NEW



Model	W X H X D(mm)
PBT-3P	33×65×24(PG)
PBT-4P	40×60×24(PG)
PBT-6P	50×70×24
TJ-4P	50×102×40
TJ-6P	55×125×40
TJ-6P-K	55×91×43
TJ-10P	75×110×40
TJ-15P	100×180×75
TJ-15P-S	100×180×75
TJ-20P-M	100×180×75
TJ-20P-S	100×223×75
TJ-20P-M	100×223×75
TJ-30P-S	150×200×100
TJ-30P-M	200×200×95
TJ-40P-S	150×250×100
TJ-40P-M	200×250×100
TJ-45P	190×380×100
TJ-50P	190×380×100
TJ-60P	190×380×100



Plastic terminal block box - junction box



Terminal block

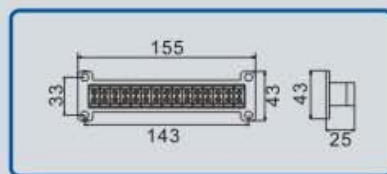

TB-15P-M

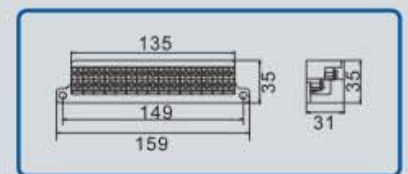

TB-15P-S

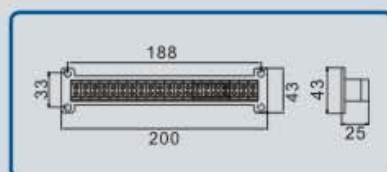

TB-20P-M

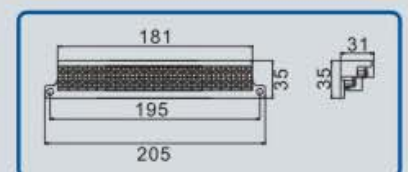

TB-20P-S

Stainless steel wall mount enclosure

Stainless steel terminal box

Stainless steel wall mount enclosure

Material: enclosure and door manufactured from AISI 304L sheet steel (AISI 316L on request)

Flat mounting plate manufactured from galvanised sheet steel. Hinges in stainless steel

Thickness of sheet steel: enclosure & door: sheet steel 1.2mm till size STX6 820, then 1.5mm

Thickness of mounting plate: zinc coated steel 1.5mm till size STX6 820 then 2.0mm

Supply include: enclosure body, door with lock & galvanised mounted plate, seal gasket and fixing accessories

Wall mount brackets 4pcs/set to be offered separately. Protection degree: IP 66 Impact resistance IK10



Stainless steel box with single blank door



Stainless steel box with inner door - STXI



Stainless steel box with glazed door - STXP

Stainless steel box with inner door+ glazed door - STXIP

Model STX	Model STXI	Model STXP	Model STXIP	W × H × D(mm)
STX2 215	STXI2 215	STXP2 215	STXIP2 215	200X200X150
STX2 2515	STXI2 2515	STXP2 2515	STXIP2 2515	200×250×150
STX25 2515	STXI25 2515	STXP25 2515	STXIP25 2515	250×250×150
STX2 315	STXI2 315	STXP2 315	STXIP2 315	200×300×150
STX25 315	STXI25 315	STXP25 315	STXIP25 315	250×300×150
STX3 315	STXI3 315	STXP3 315	STXIP3 315	300×300×150
STX3 415	STXI3 415	STXP3 415	STXIP3 415	300×400×150
STX3 420	STXI3 420	STXP3 420	STXIP3 420	300×400×200
STX3 515	STXI3 515	STXP3 515	STXIP3 515	300×500×150
STX4 315	STXI4 315	STXP4 315	STXIP4 315	400×300×150
STX4 420	STXI4 420	STXP4 420	STXIP4 420	400×400×200
STX4 520	STXI4 520	STXP4 520	STXIP4 520	400×500×200
STX4 620	STXI4 620	STXP4 620	STXIP4 620	400×600×200
STX5 520	STXI5 520	STXP5 520	STXIP5 520	500×500×200
STX5 725	STXI5 725	STXP5 725	STXIP5 725	500×700×250
STX6 420	STXI6 420	STXP6 420	STXIP6 420	600×400×200

Model STX	Model STXI	Model STXP	Model STXIP	W × H × D(mm)
STX6 620	STXI6 620	STXP6 620	STXIP6 620	600×600×200
STX6 625	STXI6 625	STXP6 625	STXIP6 625	600×600×250
STX6 630	STXI6 630	STXP6 630	STXIP6 630	600×600×300
STX6 820	STXI6 820	STXP6 820	STXIP6 820	600×800×200
STX6 1020	STXI6 1020	STXP6 1020	STXIP6 1020	600×1000×200
STX8 1020	STXI8 1020	STXP8 1020	STXIP8 1020	800×1000×200
STX6 825	STXI6 825	STXP6 825	STXIP6 825	600×800×250
STX6 1025	STXI6 1025	STXP6 1025	STXIP6 1025	600×1000×250
STX8 1225	STXI8 1225	STXP8 1225	STXIP8 1225	800×1200×250
STX6 830	STXI6 830	STXP6 830	STXIP6 830	600×800×300
STX6 1230	STXI6 1230	STXP6 1230	STXIP6 1230	600×1200×300
STX8 830	STXI8 830	STXP8 830	STXIP8 830	800×800×300
STX8 1030	STXI8 1030	STXP8 1030	STXIP8 1030	800×1000×300
STX8 1230	STXI8 1230	STXP8 1230	STXIP8 1230	800×1200×300
STX6 840	STXI6 840	STXP6 840	STXIP6 840	600×800×400
STX8 1440	STXI8 1440	STXP8 1440	STXIP8 1440	800×1400×400

more size to be request to the clients...



Stainless steel terminal box

Material: boxes and cover manufactured from thickness 1.2mm

AISI 304L (AISI316 on request)

Cover fixing with stainless steel screws.

Protection degree: IP 66

Impact resistance IK10

Supply include: enclosure & cover(sheet steel 1.2mm), sealing gasket and fixing accessories

Galvanised mounting plate to be offered separately

Wall mount brackets to be offered separately

Din-rail to be offered separately

Stainless steel terminal box

Model	W × H × D(mm)
TLX15158	150×150×80
TLX151512	150×150×120
TLX201512	200×150×120
TLX20208	200×200×80
TLX30158	300×150×80
TLX301512	300×150×120

Model	W × H × D(mm)
TLX30208	300×200×80
TLX302012	300×200×120
TLX401512	400×150×120
TLX40208	400×200×80
TLX403012	400×300×120
TLX404012	400×400×120

Model	W × H × D(mm)
TLX502012	500×200×120
TLX503012	500×300×120
TLX602012	600×200×120
TLX603012	600×300×120
TLX802012	800×200×120
TLX804012	800×400×120

more size to be request to the clients...



Accessories for stainless steel box

Lock for STX stainless steel enclosure



Wall mount brackets for STX stainless steel wall mount box

Model: WCX-010

Material: stainless steel AISI304

Package: 4pcs/set with fixing accessories

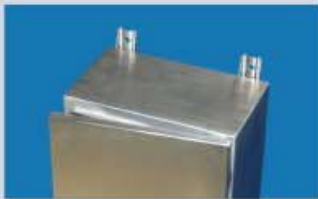

WCX-010



Wall mount brackets for TLX stainless steel terminal box

Model: WLX-010

Material: stainless steel AISI304

Package: 4pcs/set with fixing accessories



WLX-010



Canopy for STX stainless steel wall mount box

Model: TTX

Recommended for outdoor installation-Manufactured in 1.2mm AISI 304 stainless steel. Package: 1 piece



Canopy

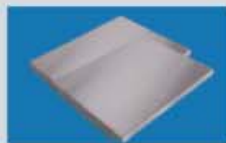

Model	For box size(mm)	
	W	D
TTX1 03	300	150
TTX2 03	300	200
TTX0 04	400	150
TTX1 04	400	200
TTX2 04	400	250
TTX3 04	400	300
TTX0 05	500	150
TTX1 05	500	200
TTX2 05	500	250

Model	For box size(mm)	
	W	D
TTX3 05	500	300
TTX0 06	600	200
TTX1 06	600	250
TTX2 06	600	300
TTX3 06	600	400
TTX0 08	800	200
TTX1 08	800	250
TTX2 08	800	300
TTX3 08	800	400

more size to be request to the clients...

Mounting plate for TLX stainless steel terminal box

Manufactured in 1.5mm galvanised sheet steel, for box MODEL TLX, TL, TB series

Package: 1 piece



Model	For box size(mm)	
	W	H
TL1515	150	150
TL2015	200	150
TL2020	200	200
TL3015	300	150
TL3020	300	200
TL4015	400	150
TL4020	400	200

Model	For box size(mm)	
	W	H
TL4030	400	300
TL4040	400	400
TL5020	500	200
TL5030	500	300
TL6020	600	200
TL8020	800	200
TL8040	800	400

more size to be request to the clients...

Plinth for AR8X, AR9X stainless steel cabinet

Standard plinth: H=100mm, H=200mm PLX is made up of 1.5mm stainless steel



Stainless steel plinth PLX1, PLX2

Model		Cabinet size(mm)	
H100	H200	Width	Depth
PLX1 35	PLX2 35	300	500
PLX1 36	PLX2 36	300	600
PLX1 38	PLX2 38	300	800
PLX1 45	PLX2 45	400	500
PLX1 46	PLX2 46	400	600
PLX1 64	PLX2 64	600	400
PLX1 65	PLX2 65	600	500
PLX1 66	PLX2 66	600	600

Model		Cabinet size(mm)	
H100	H200	Width	Depth
PLX1 86	PLX2 86	800	600
PLX1 88	PLX2 88	800	800
PLX1 104	PLX2 104	1000	400
PLX1 105	PLX2 105	1000	500
PLX1 106	PLX2 106	1000	600
PLX1 108	PLX2 108	1000	800
PLX1 124	PLX2 124	1200	400
PLX1 125	PLX2 125	1200	500

more size to be request to the clients...

AR9X stainless steel cabinet AR9XP stainless steel cabinet



Stainless steel cabinet AR9X type



Stainless steel cabinet with glazed door AR9XP type

AR9X stainless steel cabinet

Material: stainless steel AISI304 or AISI316 (on request)
 Thickness: front door 2.0mm/ rear panel 1.5mm/ side panels 1.5mm/ top cover & bottom cable plate 1.5mm/ galvanised mounting plate 2.5mm/
 9-folded rails 1.5mm
 Protection ratings: IP 55
 Impact resistance IK10

Supply include:

9-folded rails 4pcs/set, door complete with MS821-X locking system and hinges , rear panel, side panels 2pcs/set, top cover, bottom with removable cable entry, 4 lifting eyebolts

AR9XP stainless steel cabinet with glazed door

Supply include:

9-folded rails 4pcs/set, door complete with MS821-X locking system with plexiglass window, and hinges , rear panel, side panels 2pcs/set, top cover, bottom with removable cable entry, 4 lifting eyebolts

Model	Model	W × H × D mm	NO. of door
AR9X 146/4	AR9XP 146/4	600 X 1400 X 400	1
AR9X 146/6	AR9XP 146/6	600 X 1400 X 600	1
AR9X 146/8	AR9XP 146/8	600 X 1400 X 800	1
AR9X 148/4	AR9XP 148/4	800 X 1400 X 400	1
AR9X 148/6	AR9XP 148/6	800 X 1400 X 600	1
AR9X 148/8	AR9XP 148/8	800 X 1400 X 800	1
AR9X 166/6	AR9XP 166/6	600 X 1600 X 600	1
AR9X 166/8	AR9XP 166/8	600 X 1600 X 800	1
AR9X 168/6	AR9XP 168/6	800 X 1600 X 600	1
AR9X 168/8	AR9XP 168/8	800 X 1600 X 800	1
AR9X 186/4	AR9XP 186/4	600 X 1800 X 400	1
AR9X 186/5	AR9XP 186/5	600 X 1800 X 500	1
AR9X 186/6	AR9XP 186/6	600 X 1800 X 600	1
AR9X 186/8	AR9XP 186/8	600 X 1800 X 800	1
AR9X 188/4	AR9XP 188/4	800 X 1800 X 400	1
AR9X 188/5	AR9XP 188/5	800 X 1800 X 500	1
AR9X 188/6	AR9XP 188/6	800 X 1800 X 600	1
AR9X 1810/4	AR9XP 1810/4	1000 X 1800 X 400	1
AR9X 1810/5	AR9XP 1810/5	1000 X 1800 X 500	1

Model	Model	W × H × D mm	No. of door
AR9X 203/8	AR9XP 203/8	300 X 2000 X 800	1
AR9X 204/5	AR9 XP 204/5	400 X 2000 X 500	1
AR9X 204/6	AR9XP 204/6	400 X 2000 X 600	1
AR9X 206/4	AR9XP 206/4	600 X 2000 X 400	1
AR9X 206/5	AR9XP 206/5	600 X 2000 X 500	1
AR9X 206/6	AR9XP 206/6	600 X 2000 X 600	1
AR9X 206/8	AR9XP 206/8	600 X 2000 X 800	1
AR9X 208/4	AR9XP 208/4	800 X 2000 X 400	1
AR9X 208/5	AR9XP 208/5	800 X 2000 X 500	1
AR9X 208/6	AR9XP 208/6	800 X 2000 X 600	1
AR9X 208/8	AR9XP 208/8	800 X 2000 X 800	1
AR9X 2010/4	AR9XP 2010/4	1000 X 2000 X 400	1
AR9X 2010/5	AR9XP 2010/5	1000 X 2000 X 500	1
AR9X 2010/6	AR9XP 2010/6	1000 X 2000 X 600	1
AR9X 2010/8	AR9XP 2010/8	1000 X 2000 X 800	1
AR9X 2012/4	AR9XP 2012/4	1200 X 2000 X 400	1
AR9X 226/8	AR9XP 226/8	600 X 2200 X 800	1
AR9X 228/6	AR9XP 228/6	800 X 2200 X 600	1
AR9X 228/8	AR9XP 228/8	800 X 2200 X 800	1

Model	Model	W × H × D mm	NO. of door
AR9X 1810/4D	AR9XP 1810/4D	1000 X 1800 X 400	2
AR9X 1810/5D	AR9XP 1810/5D	1000 X 1800 X 500	2
AR9X 1810/6D	AR9XP 1810/6D	1000 X 1800 X 600	2
AR9X 1812/4D	AR9XP 1812/4D	1200 X 1800 X 400	2
AR9X 1812/5D	AR9XP 1812/5D	1200 X 1800 X 500	2
AR9X 1812/6D	AR9XP 1812/6D	1200 X 1800 X 600	2

Model	Model	W × H × D mm	NO. of door
AR9X 2010/8D	AR9XP 2010/8D	1000 X 2000 X 800	2
AR9X 2012/4D	AR9XP 2012/4D	1200 X 2000 X 400	2
AR9X 2012/5D	AR9XP 2012/5D	1200 X 2000 X 500	2
AR9X 2012/6D	AR9XP 2012/6D	1200 X 2000 X 600	2
AR9X 2012/8D	AR9XP 2012/8D	1200 X 2000 X 800	2
AR9X 2210/6D	AR9XP 2210/6D	1000 X 2200 X 600	2

more size to be request to the clients...



AR8X one piece stainless steel cabinet

AR8X one piece stainless steel cabinet

Material: stainless steel AISI304 or AISI316 (on request)

Protection ratings: IP 55

Impact resistance IK10

Thickness of the sheet steel:

Front door: 2.0mm/ rear panel 1.5mm / enclosure body 1.5mm/top cover & bottom cable plate 1.5mm/galvanised mounting plate: 2.5mm

Supply Include:

AR8X structure enclosure body, door complete with MS821-X locking system and hinges ,rear panel, top cover, bottom with removable cable entry, 4 lifting eyebolts



Stainless steel cabinet AR8X+type

Model	W × H × D mm	no. of door
AR8X 1010/3D	1000 X 1000 X 300	2
AR8X 128/3	800 X 1200 X 300	1
AR8X 1210/3D	1000 X 1200 X 300	2
AR8 X1212/4D	1200 X 1200 X 400	2
AR8X 146/3	600 X 1400 X 300	1
AR8X 146/4	600 X 1400 X 400	1
AR8X 148/3	800 X 1400 X 300	1
AR8X 148/4	800 X 1400 X 400	1
AR8X 1410/4D	1000 X 1400 X 400	2
AR8X 1412/4D	1200 X 1400 X 400	2
AR8X 166/3	600 X 1600 X 300	1
AR8X 166/4	600 X 1600 X 400	1
AR8X 168/3	800 X 1600 X 300	1
AR8X 168/4	800 X 1600 X 400	1
AR8X 1610/3D	1000 X 1600 X 300	2
AR8X 1610/4D	1000 X 1600 X 400	2
AR8X 1612/3D	1200 X 1600 X 300	2
AR8X 1612/4D	1200 X 1600 X 400	2
AR8X 186/3	600 X 1800 X 300	1
AR8X 186/4	600 X 1800 X 400	1
AR8X 186/5	600 X 1800 X 500	1
AR8X 186/6	600 X 1800 X 600	1
AR8X 188/3	800 X 1800 X 300	1
AR8X 188/4	800 X 1800 X 400	1

Model	W × H × D mm	no. of door
AR8X 188/5	800 X 1800 X 500	1
AR8X 188/6	800 X 1800 X 600	1
AR8X 1810/4D	1000 X 1800 X 400	2
AR8X 1810/5D	1000 X 1800 X 500	2
AR8X 1812/4D	1200 X 1800 X 400	2
AR8X 1812/5D	1200 X 1800 X 500	2
AR8X 1816/4D	1600 X 1800 X 400	2
AR8X 1816/5D	1600 X 1800 X 500	2
AR8X 206/3	600 X 2000 X 300	1
AR8X 206/4	600 X 2000 X 400	1
AR8X 206/5	600 X 2000 X 500	1
AR8X 206/6	600 X 2000 X 600	1
AR8X 208/3	800 X 2000 X 300	1
AR8X 208/4	800 X 2000 X 400	1
AR8X 208/5	800 X 2000 X 500	1
AR8X 208/6	800 X 2000 X 600	1
AR8X 2010/4D	1000 X 2000 X 400	2
AR8X 2010/5D	1000 X 2000 X 500	2
AR8X 2012/4D	1200 X 2000 X 400	2
AR8X 2012/5D	1200 X 2000 X 500	2
AR8X 2012/6D	1200 X 2000 X 600	2
AR8X 2016/4D	1600 X 2000 X 400	2
AR8X 2016/5D	1600 X 2000 X 500	2
AR8X 2016/6D	1600 X 2000 X 600	2

more size to be request to the clients...

Transportation of AR8,AR9,AR8X,AR9X cabinet

(1)By forktruck

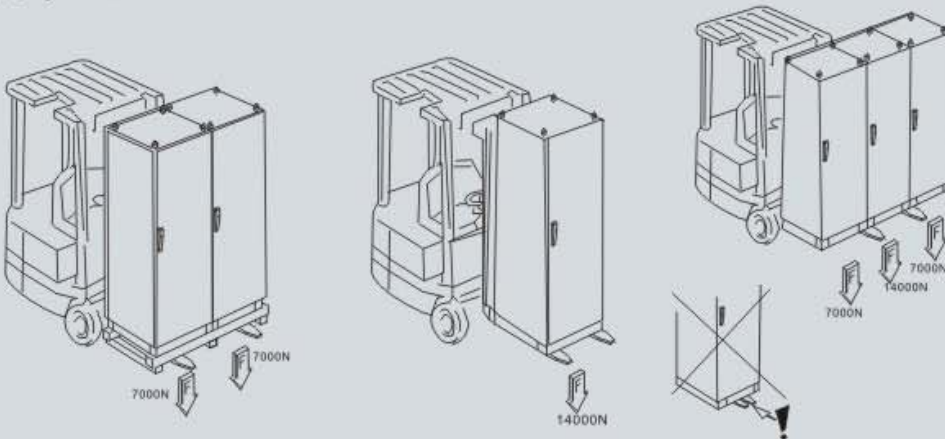

(3)Accessories

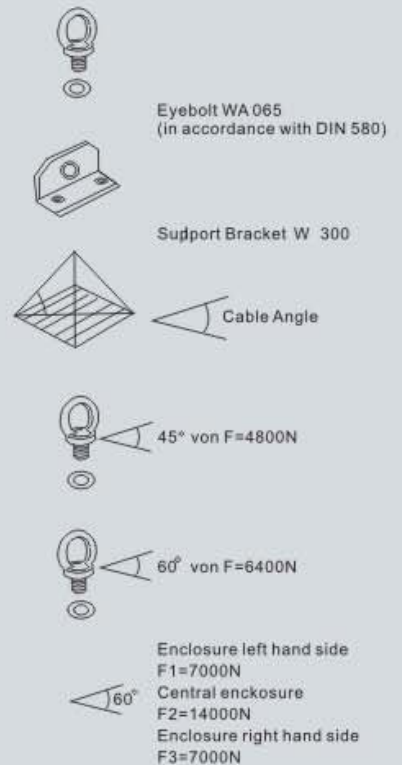

(2)By crane

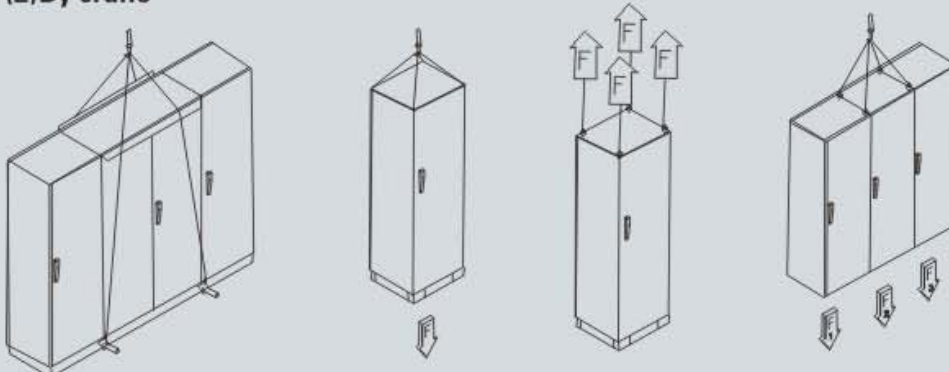

AR9000 floor stand cabinet-single door

AR9000 floor stand cabinet-double door



AR9000 floor stand cabinet

Supply Include

Front door with Reinforcing frame, hinges and MS821 lock system, 9 folded profiles 4pcs/set, rear panel, mounting plate & 4 mounting plate supports 4 lifting eyebolts, top cover, removable cable gland plate

Standard Configuration

Paint finish epoxy polyester powder coating textured finish

Color:RAL 7032 RAL 7035

Profile:9-fold profile

Material: cold rolling steel

Thickness:front door:2.0mm,rear panel:1.5mm

Mounting plate: zinc coated 2.5mm

Protection degree:IP55

Impact resistance: IK10

AR9000 floor stand cabinet

Single door AR9000 cabinet

Model	Dimension(mm)
	W × H × D
AR9 146/4	600 X1400 X 400
AR9 146/6	600 X1400 X 600
AR9 146/8	600 X1400 X 800
AR9 148/4	800 X1400 X 400
AR9 148/6	800 X1400 X 600
AR9 148/8	800 X1400 X 800
AR9 166/6	600 X1600 X 600
AR9 166/8	600 X1600 X 800
AR9 168/6	800 X1600 X 600
AR9 168/8	800 X1600 X 800
AR9 186/4	600 X1800 X 400
AR9 186/5	600 X1800 X 500
AR9 186/6	600 X1800 X 600
AR9 186/8	600 X1800 X 800
AR9 188/4	800 X1800 X 400
AR9 188/5	800 X1800 X 500
AR9 188/6	800 X1800 X 600
AR9 1810/4	1000X1800 X 400
AR9 1810/5	1000X1800 X 500
AR9 1810/6	1000X1800 X 600
AR9 203/5	300 X2000 X 500
AR9 203/6	300 X2000 X 600

Model	Dimension(mm)
	W × H × D
AR9 203/8	300 X 2000 X 800
AR9 204/5	400 X 2000 X 500
AR9 204/6	400 X 2000 X 600
AR9 206/4	600 X 2000 X 400
AR9 206/5	600 X 2000 X 500
AR9 206/6	600 X 2000 X 600
AR9 206/8	600 X 2000 X 800
AR9 208/4	800 X 2000 X 400
AR9 208/5	800 X 2000 X 500
AR9 208/6	800 X 2000 X 600
AR9 208/8	800 X 2000 X 800
AR9 2010/4	1000 X 2000 X 400
AR9 2010/5	1000 X 2000 X 500
AR9 2010/6	1000 X 2000 X 600
AR9 2010/8	1000 X 2000 X 800
AR9 2012/4	1200 X 2000 X 400
AR9 226/8	600 X 2200 X 800
AR9 228/6	800 X 2200 X 600
AR9 228/8	800 X 2200 X 800
AR9 2210/6	1000 X 2200 X 600
AR9 2210/8	1000 X 2200 X 800

Double door AR9000 cabinet

Model	Dimension(mm)
	W × H × D
AR9 1810/4D	1000 X 1800X 400
AR9 1810/5D	1000 X 1800X 500
AR9 1810/6D	1000 X 1800X 600
AR9 1812/4D	1200 X 1800X 400
AR9 1812/5D	1200 X 1800X 500
AR9 1812/6D	1200 X 1800X 600
AR9 2010/4D	1000 X 2000X 400
AR9 2010/5D	1000 X 2000X 500
AR9 2010/6D	1000 X 2000X 600

Model	Dimension(mm)
	W × H × D
AR9 2010/8D	1000 X 2000X 800
AR9 2012/4D	1200 X 2000X 400
AR9 2012/5D	1200 X 2000X 500
AR9 2012/6D	1200 X 2000X 600
AR9 2012/8D	1200 X 2000X 800
AR9 2210/6D	1000 X 2200X 600
AR9 2210/8D	1000 X 2200X 800
AR9 2212/6D	1200 X 2200X 600
AR9 2212/8D	1200 X 2200X 800

more size to be request to the clients...



Plexiglass door/inner door for AR9000 cabinet AR8000 one piece floor stand cabinet

Plexiglass door / inner door for AR9000 cabinet



Plexiglass door ARPX model Inner door ARID model

Color: RAL 7032 or RAL 7035
Protection degree: IP 55
Material: Plexiglass 5.0mm
Impact resistance: IK10

ARPX plexiglass door supply include:
Plexiglass door thickness 5.0mm and fixing accessories
lock system,hinges

ARID inner door supply include:
inner door and fixing accessories,lock system,hinges

Plexiglass door / Inner door

Plexiglass door Model	Inner door Model	For box size(mm)	
		W	H
ARPX 126	ARID 126	600	1200
ARPX 128	ARID 128	800	1200
ARPX 146	ARID 146	600	1400
ARPX 148	ARID 148	800	1400
ARPX 166	ARID 166	600	1600
ARPX 168	ARID 168	800	1600
ARPX 186	ARID 186	600	1800
ARPX 188	ARID 188	800	1800
ARPX 1810	ARID 1810	1000	1800
ARPX 206	ARID 206	600	2000
ARPX 208	ARID 208	800	2000
ARPX 2010	ARID 2010	1000	2000
ARPX 226	ARID 226	600	2200
ARPX 228	ARID 228	800	2200

more size to be request to the client...

AR8000 one piece floor stand cabinet

Material: cold steel rolling sheet

Protection ratings:IP 55, Impact resistance IK10

Color:RAL7032 RAL7035,paint finish epoxy polyester powder coating textured finish

Thickness of the sheet steel:Front door: 2.0mm/ rear panel 1.5mm / enclosure body 1.5mm/top cover &bottom cable plate 1.5mm/
galvanised mounting plate: 2.5mm

Supply Include:

AR8 structure enclosure body,door complete with MS821-X locking system and hinges ,rear panel,top cover,bottom with removable
cable entry,4 lifting eyebolts

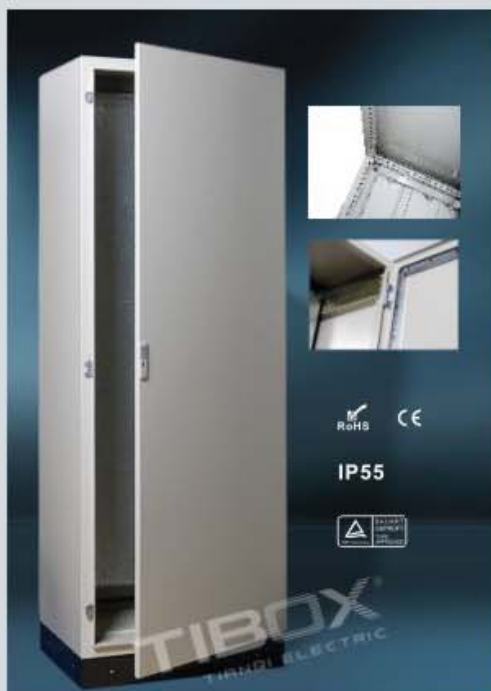

AR8000 one piece cabinet

AR8000 one piece cabinet-single door/double door

Model	W × H × D	NO. of door	Model	W × H × D	NO. of door
AR8 1010/3D	1000 X 1000 X 300	2	AR8 188/5	800 X 1800 X 500	1
AR8 128/3	800 X 1200 X 300	1	AR8 188/6	800 X 1800 X 600	1
AR8 1210/3D	1000 X 1200 X 300	2	AR8 1810/4D	1000 X 1800 X 400	2
AR8 1212/4D	1200 X 1200 X 400	2	AR8 1810/5D	1000 X 1800 X 500	2
AR8 146/3	600 X 1400 X 300	1	AR8 1812/4D	1200 X 1800 X 400	2
AR8 146/4	600 X 1400 X 400	1	AR8 1812/5D	1200 X 1800 X 500	2
AR8 148/3	800 X 1400 X 300	1	AR8 1816/4D	1600 X 1800 X 400	2
AR8 148/4	800 X 1400 X 400	1	AR8 1816/5D	1600 X 1800 X 500	2
AR8 1410/4D	1000 X 1400 X 400	2	AR8 206/3	600 X 2000 X 300	1
AR8 1412/4D	1200 X 1400 X 400	2	AR8 206/4	600 X 2000 X 400	1
AR8 166/3	600 X 1600 X 300	1	AR8 206/5	600 X 2000 X 500	1
AR8 166/4	600 X 1600 X 400	1	AR8 206/6	600 X 2000 X 600	1
AR8 168/3	800 X 1600 X 300	1	AR8 208/3	800 X 2000 X 300	1
AR8 168/4	800 X 1600 X 400	1	AR8 208/4	800 X 2000 X 400	1
AR8 1610/3D	1000 X 1600 X 300	2	AR8 208/5	800 X 2000 X 500	1
AR8 1610/4D	1000 X 1600 X 400	2	AR8 208/6	800 X 2000 X 600	1
AR8 1612/3D	1200 X 1600 X 300	2	AR8 2010/4D	1000 X 2000 X 400	2
AR8 1612/4D	1200 X 1600 X 400	2	AR8 2010/5D	1000 X 2000 X 500	2
AR8 186/3	600 X 1800 X 300	1	AR8 2012/4D	1200 X 2000 X 400	2
AR8 186/4	600 X 1800 X 400	1	AR8 2012/5D	1200 X 2000 X 500	2
AR8 186/5	600 X 1800 X 500	1	AR8 2012/6D	1200 X 2000 X 600	2
AR8 186/6	600 X 1800 X 600	1	AR8 2016/4D	1600 X 2000 X 400	2
AR8 188/3	800 X 1800 X 300	1	AR8 2016/5D	1600 X 2000 X 500	2
AR8 188/4	800 X 1800 X 400	1	AR8 2016/6D	1600 X 2000 X 600	2

more size to be request to the client...

AR9000K floor stand cabinet

un-assembled type / knock-down type

		9-FOLDED PROFILES	TOP COVER & BOTTOM	FRONT DOOR BACK PANEL	FRONT DOOR	BACK PANEL	MOUNTING PLATE	SIDE PANELS
MODEL	SIZE(W H D) mm	9-FOLDED PROFILES	TOP COVER & BOTTOM	FRONT DOOR BACK PANEL	FRONT DOOR	BACK PANEL	MOUNTING PLATE	SIDE PANELS
AR9 164/4K	400X1600X400	F16	TCB44	FBD164	FD164	BD164	MP164	ARSP164
AR9 164/5K	400X1600X500	F16	TCB45	FBD164	FD164	BD164	MP164	ARSP165
AR9 164/6K	400X1600X600	F16	TCB46	FBD164	FD164	BD164	MP164	ARSP166
AR9 166/4K	600X1600X400	F16	TCB64	FBD166	FD166	BD166	MP166	ARSP164
AR9 166/5K	600X1600X500	F16	TCB65	FBD166	FD166	BD166	MP166	ARSP165
AR9 166/6K	600X1600X600	F16	TCB66	FBD166	FD166	BD166	MP166	ARSP166
AR9 168/4K	800X1600X400	F16	TCB84	FBD168	FD168	BD168	MP168	ARSP164
AR9 168/5K	800X1600X500	F16	TCB85	FBD168	FD168	BD168	MP168	ARSP165
AR9 168/6K	800X1600X600	F16	TCB86	FBD168	FD168	BD168	MP168	ARSP166
AR9 184/4K	400X1800X400	F18	TCB44	FBD184	FD184	BD184	MP184	ARSP184
AR9 184/5K	400X1800X500	F18	TCB45	FBD184	FD184	BD184	MP184	ARSP185
AR9 184/6K	400X1800X600	F18	TCB46	FBD184	FD184	BD184	MP184	ARSP186
AR9 186/4K	600X1800X400	F18	TCB64	FBD186	FD186	BD186	MP186	ARSP184
AR9 186/5K	600X1800X500	F18	TCB65	FBD186	FD186	BD186	MP186	ARSP185
AR9 186/6K	600X1800X600	F18	TCB66	FBD186	FD186	BD186	MP186	ARSP186
AR9 188/4K	800X1800X400	F18	TCB84	FBD188	FD188	BD188	MP188	ARSP184
AR9 188/5K	800X1800X500	F18	TCB85	FBD188	FD188	BD188	MP188	ARSP185
AR9 188/6K	800X1800X600	F18	TCB86	FBD188	FD188	BD188	MP188	ARSP186
AR9 188/8K	800X1800X800	F18	TCB88	FBD188	FD188	BD188	MP188	ARSP188
AR9 1810/4K	1000X1800X400	F18	TCB104	FBD1810	FD1810	BD1810	MP1810	ARSP184
AR9 1810/5K	1000X1800X500	F18	TCB105	FBD1810	FD1810	BD1810	MP1810	ARSP185
AR9 1810/6K	1000X1800X600	F18	TCB106	FBD1810	FD1810	BD1810	MP1810	ARSP186
AR9 204/4K	400X2000X400	F20	TCB44	FBD204	FD204	BD204	MP204	ARSP204
AR9 204/5K	400X2000X500	F20	TCB45	FBD204	FD204	BD204	MP204	ARSP205
AR9 204/6K	400X2000X600	F20	TCB46	FBD204	FD204	BD204	MP204	ARSP206
AR9 206/4K	600X2000X400	F20	TCB64	FBD206	FD206	BD206	MP206	ARSP204
AR9 206/5K	600X2000X500	F20	TCB65	FBD206	FD206	BD206	MP206	ARSP205
AR9 206/6K	600X2000X600	F20	TCB66	FBD206	FD206	BD206	MP206	ARSP206
AR9 206/8K	600X2000X800	F20	TCB68	FBD206	FD206	BD206	MP206	ARSP208
AR9 208/4K	800X2000X400	F20	TCB84	FBD208	FD208	BD208	MP208	ARSP204
AR9 208/5K	800X2000X500	F20	TCB85	FBD208	FD208	BD208	MP208	ARSP205
AR9 208/6K	800X2000X600	F20	TCB86	FBD208	FD208	BD208	MP208	ARSP206
AR9 208/8K	800X2000X800	F20	TCB88	FBD208	FD208	BD208	MP208	ARSP208
AR9 2010/4K	1000X2000X400	F20	TCB104	FBD2010	FD2010	BD2010	MP2010	ARSP204
AR9 2010/5K	1000X2000X500	F20	TCB105	FBD2010	FD2010	BD2010	MP2010	ARSP205
AR9 2010/6K	1000X2000X600	F20	TCB106	FBD2010	FD2010	BD2010	MP2010	ARSP206
AR9 226/4K	600X2200X400	F22	TCB64	FBD226	FD226	BD226	MP226	ARSP224
AR9 226/5K	600X2200X500	F22	TCB65	FBD226	FD226	BD226	MP226	ARSP225
AR9 226/6K	600X2200X600	F22	TCB66	FBD226	FD226	BD226	MP226	ARSP226
AR9 226/8K	600X2200X800	F22	TCB68	FBD226	FD226	BD226	MP226	ARSP228
AR9 228/4K	800X2200X400	F22	TCB84	FBD228	FD228	BD228	MP228	ARSP224
AR9 228/5K	800X2200X500	F22	TCB85	FBD228	FD228	BD228	MP228	ARSP225
AR9 228/6K	800X2200X600	F22	TCB86	FBD228	FD228	BD228	MP228	ARSP226
AR9 2210/4K	1000X2200X400	F22	TCB104	FBD2210	FD2210	BD2210	MP2210	ARSP224
AR9 2210/5K	1000X2200X500	F22	TCB105	FBD2210	FD2210	BD2210	MP2210	ARSP225
AR9 2210/6K	1000X2200X600	F22	TCB106	FBD2210	FD2210	BD2210	MP2210	ARSP226



AR9000K floor stand cabinet un-assembled type / knock -down type

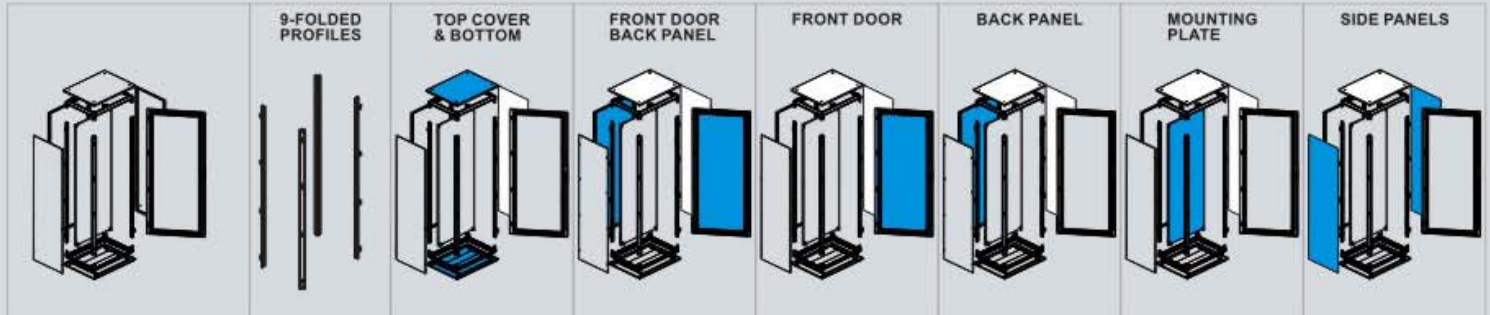

DOUBLE DOOR MODEL	SIZE(W H D) mm	9-FOLDED PROFILES	TOP COVER & BOTTOM	FRONT DOOR BACK PANEL	FRONT DOOR	BACK PANEL	MOUNTING PLATE	SIDE PANELS
AR9D 1610/4K	1000X1600X400	F16/D	TCB104/D	FBD1610/D	FD1610/D	BD1610	MP1610	ARSP164
AR9D 1610/5K	1000X1600X500	F16/D	TCB105/D	FBD1610/D	FD1610/D	BD1610	MP1610	ARSP165
AR9D 1612/4K	1200X1600X400	F16/D	TCB124/D	FBD1612/D	FD1612/D	BD1612	MP1612	ARSP164
AR9D 1612/5K	1200X1600X500	F16/D	TCB125/D	FBD1612/D	FD1612/D	BD1612	MP1612	ARSP165
AR9D 1810/4K	1000X1800X400	F18/D	TCB104/D	FBD1810/D	FD1810/D	BD1810	MP1810	ARSP184
AR9D 1810/5K	1000X1800X500	F18/D	TCB105/D	FBD1810/D	FD1810/D	BD1810	MP1810	ARSP185
AR9D 1810/6K	1000X1800X600	F18/D	TCB106/D	FBD1810/D	FD1810/D	BD1810	MP1810	ARSP186
AR9D 1812/4K	1200X1800X400	F18/D	TCB124/D	FBD1812/D	FD1812/D	BD1812	MP1812	ARSP184
AR9D 1812/5K	1200X1800X500	F18/D	TCB125/D	FBD1812/D	FD1812/D	BD1812	MP1812	ARSP185
AR9D 1812/6K	1200X1800X600	F18/D	TCB126/D	FBD1812/D	FD1812/D	BD1812	MP1812	ARSP186
AR9D 2010/4K	1000X2000X400	F20/D	TCB104/D	FBD2010/D	FD2010/D	BD2010	MP2010	ARSP204
AR9D 2010/5K	1000X2000X500	F20/D	TCB105/D	FBD2010/D	FD2010/D	BD2010	MP2010	ARSP205
AR9D 2010/6K	1000X2000X600	F20/D	TCB106/D	FBD2010/D	FD2010/D	BD2010	MP2010	ARSP206
AR9D 2012/4K	1200X2000X400	F20/D	TCB124/D	FBD2012/D	FD2012/D	BD2012	MP2012	ARSP204
AR9D 2012/5K	1200X2000X500	F20/D	TCB125/D	FBD2012/D	FD2012/D	BD2012	MP2012	ARSP205
AR9D 2012/6K	1200X2000X600	F20/D	TCB126/D	FBD2012/D	FD2012/D	BD2012	MP2012	ARSP206
AR9D 2210/5K	1000X2200X500	F22/D	TCB105/D	FBD2210/D	FD2210/D	BD2210	MP2210	ARSP225
AR9D 2210/6K	1000X2200X600	F22/D	TCB106/D	FBD2210/D	FD2210/D	BD2210	MP2210	ARSP226
AR9D 2212/5K	1200X2200X500	F22/D	TCB125/D	FBD2212/D	FD2212/D	BD2212	MP2212	ARSP225
AR9D 2212/6K	1200X2200X600	F22/D	TCB126/D	FBD2212/D	FD2212/D	BD2212	MP2212	ARSP226



AR9K metal floor stand cabinets comprise a 9-folded profile structure, un-welded at the top and bottom of the frame, with removable screws in vertical profiles for strength and versatility with the cabinets. Thermosetting epoxy polyester powder coating in textured RAL 7035 or RAL7032

Supply include

- 9-folded profiles 4pcs/set (model:F):hinged uprights, panel mounts and locking elements assembled.
- Top cover and base (Model: TCB):welded top frame , welded base,mounting plate fixing support.
- Back panel and front door (Model: FBD):plain door with lock, plain back panel.
- Galvanised mounting Plate(Model: MP)
- Side panels(Model: ARSP):2pcs side panels with accessories



TIBOX
TIRNGI ELECTRIC

RoHS CE IP55 

un-assembled type/knock -down type
Packed in 5 or 6 cartons(un-assembled type)
70% save in sea freight(un-assembled type)

TP/TPX series control desk



TP series control desk

Material: cold steel sheet

thickness of sheet steel

body: 1.5mm /front door:2.0mm /upper cover:2.0mm/galvanised mounting plate: 2.5mm

Color for the control desk: RAL7032 or RAL 7035

Supply include: control desk,front door with lock system, upper cover with cover stop 2pcs, 2 pcs gland cable plates,mounting plate

The accessories of plinth 100mm to be supplied separately according to the client's requirement

MODEL	W	H	D(D1)	NO.of doors	size of mounting plate(FXG)	Weight	Plinth 100mm
TP01	500 X 960 X 400(480) mm			1 door	430 X 780mm	38.8KGS	PL54-TP
TP02	600 X 960 X 400(480) mm			1 door	530 X 780mm	52KGS	PL64-TP
TP03	800 X 960 X 400(480) mm			1 door	730 X 780mm	65.2KGS	PL84-TP
TP04	1000 X 960 X 400(480) mm			2 doors	930 X 780mm	79.5KGS	PL104-TP
TP05	1200 X 960 X 400(480) mm			2 doors	1130 X 780mm	90.3KGS	PL124-TP

TPX series stainless steel control desk

Material: Stainless steel AISI304 or AISI 316

thickness of sheet steel

body: 1.5mm/front door:2.0mm/upper cover:2.0mm/galvanised mounting plate: 2.5mm

Supply include: control desk,front door with lock system, upper coverwith cover stop 2pcs, 2 pcs gland cable plates,mounting plate

The accessories of plinth 100mm to be supplied separately according to the client's requirement

MODEL	W	H	D(D1)	NO.of doors	size of mounting plate(FXG)	Weight	Plinth 100mm
TPX01	500 X 960 X 400(480) mm			1 door	430 X 780mm	38.8KGS	PL54-TPX
TPX02	600 X 960 X 400(480) mm			1 door	530 X 780mm	52KGS	PL64-TPX
TPX03	800 X 960 X 400(480) mm			1 door	730 X 780mm	65.2KGS	PL84-TPX
TPX04	1000 X 960 X 400(480) mm			2 doors	930 X 780mm	79.5KGS	PL104-TPX
TPX05	1200 X 960 X 400(480) mm			2 doors	1130 X 780mm	90.3KGS	PL124-TPX



ALP/AM series control desk



ALP /AM series control desk

Material: cold steel sheet
 Thickness of sheet steel:
 Enclosure & door: 2.0mm sheet steel,galvanised mounting plate: 2.5mm
 Color: RAL7032 or RAL7035
 Finish: epoxy polyester powder coating textured finish
 protection degree: IP55
 Front/rear door and operation panel can be opened for convent installation.
 Zinc coated mounting plate can move back and forth.

ALP series control desk (include PE, LE, AE)

Supply include: part PE,part LE, part AE
 PE part :door with lock+hinges, mounting plate,enclosure body
 AE part: door with lock+hinges, mounting plate, enclosure body
 LE part: door with lock+hinges, door support 2pcs/set,enclosure body

AM series control desk (include ME, AE)

Supply include: part ME,part AE
 ME part :door with lock+hinges, door support 2pcs/set,enclosure body
 AE part: door with lock+hinges, mounting plate, enclosure body

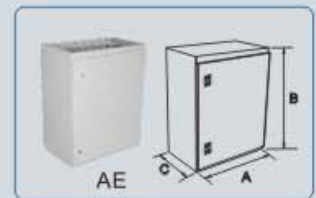
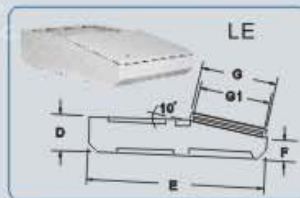
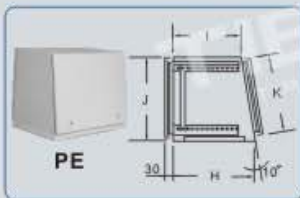

ALP control desk

ALP series control desk (include PE, LE, AE)

MODEL	PE				LE				AE		
	H	I	J	K	D	E	F	G	A	B	C
ALP41	370	295	460	425	200	835	120	425	600	770	400
ALP42	370	295	460	425	200	835	120	425	800	770	400
ALP43	370	295	460	425	200	835	120	425	1000	770	400
ALP44	370	295	460	425	200	835	120	425	1200	770	400
ALP45	370	295	460	425	200	835	120	425	1600	770	400
ALP51	440	365	460	425	200	935	120	425	600	770	500
ALP52	440	365	460	425	200	935	120	425	800	770	500
ALP53	440	365	460	425	200	935	120	425	1000	770	500
ALP54	440	365	460	425	200	935	120	425	1200	770	500
ALP55	440	365	460	425	200	935	120	425	1600	770	500



ME

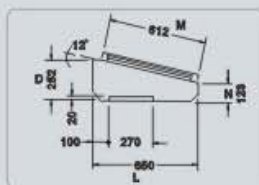

AE

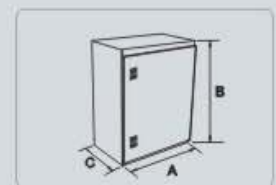

AM series control desk (include ME, AE)

MODEL	ME				AE		
	L	M	N	D	A	B	C
AM41	650	612	123	252	600	770	400
AM42	650	612	123	252	800	770	400
AM43	650	612	123	252	1000	770	400
AM44	650	612	123	252	1200	770	400
AM45	650	612	123	252	1600	770	400
AM51	750	712	123	275	600	770	500
AM52	750	712	123	275	800	770	500
AM53	750	712	123	275	1000	770	500
AM54	750	712	123	275	1200	770	500
AM55	750	712	123	275	1600	770	500



AM control desk

Accessories of AR9,AR8 floor stand cabinet



Multiple door

	Mode	Height(mm)	Mode	Height(mm)
600mm	MT602	200	MTP602	195
	MT603	300	MTP603	295
	MT604	400	MTP604	395
	MT605	500	MTP605	495
	MT606	600	MTP606	595
	MT608	800	MTP608	795
	MT609	900	MTP609	895
800mm	MT6010	1000	MTP6010	995
	MT802	200	MTP802	195
	MT803	300	MTP803	295
	MT804	400	MTP804	395
	MT805	500	MTP805	495
	MT806	600	MTP806	595
	MT808	800	MTP808	795
	MT809	900	MTP809	895
	MT8010	1000	MTP8010	995

In 2mm sheet steel complete with gasket and locking system, hinges MT: without plexiglass door
MTP: with plexiglass door

Clamp board

Model	Width(mm)	Pack
MT600	600	5PCS/SET
MT800	800	5PCS/SET

For multiple door is made up of 1.5mm, sheet steel with fixing accessories

Seal cover

Model	W X H(mm)	Pack
MT006	600x100	4
MT008	800x100	4

In 1.5mm sheet steel for sealing the top & bottom of cabinet. Supply include: 4pcs seal covers & its fixing accessories
Pack: 4pcs/set



Multiple door



Clamp board



Seal cover



Cabinet with blank front plate

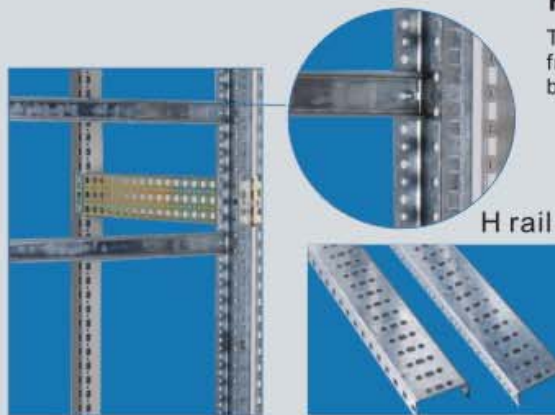

H rail

H rail for blank front plate

This rail is easy to fix on the cabinet height from 1400mm-2200mm, for fixing Din-rail C45, blank front panel (surface plate/flush plate)

H rail

Model	For cabinet height(mm)
H1400	1400mm
H1600	1600mm
H1800	1800mm
H2000	2000mm
H2200	2200mm



Surface plate



Flush plate

Blank front plate

Blank plate supplied with fixing accessories (screws with captive bush) pack: 1 piece



Surface plate

Model	cabinet width(mm)	Surface plate	
		A	B
MDP602	600	508	200
MDP603			300
MDP604			400
MDP606			600
MDP802	800	708	200
MDP803			300
MDP804			400
MDP806			600

Flush plate

Model	cabinet width(mm)	Panel(mm)	
		A	B
MDP604F	600	508	400
MDP606F			600
MDP804F			400
MDP806F	800	708	600



Accessories of AR9000 modular cabinet



Punched front panels

COMPONENT PANEL
 Manufactured in 1.5mm sheet steel
 Supplied complete with DIN rail and fixing accessories(screws and captive bush)
 Supplied with panel,cover,rail,closed with captive screws provided
 Package:1 pc with accessories

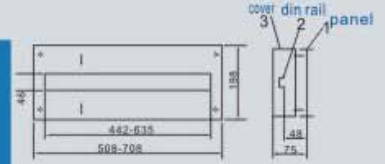
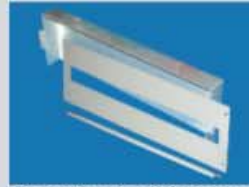
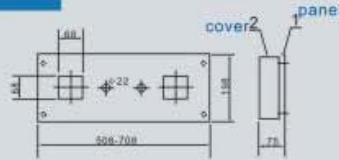
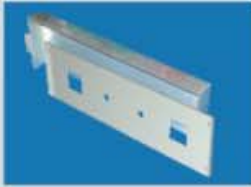

Panel for modular component

Flush panel

Cabinet Width	Ref	Description	Pcs	Model
600	1	PANEL	1	MDP03 102F
	2	COVER	1	MDP04 102
800	1	PANEL	1	MDP03 202F
	2	COVER	1	MDP04 202

Cabinet Width	Ref	Description	Pcs	Model
600	1	PANEL	1	MDP02 102F
	2	DIN RAIL 1×25P	1	
	3	COVER	1	
800	1	PANEL	1	MDP02 202F
	2	DIN RAIL 1×25P	1	
	3	COVER	1	

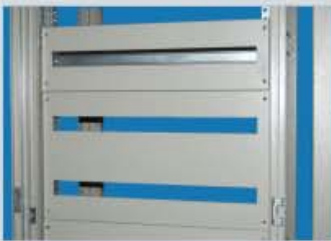

Panel for modular components

Manufactured in 1.5mm sheet steel.
 Supplied complete with zinc passivate DIN rail and fixing accessories with screws and captive bush.
 Package:singly

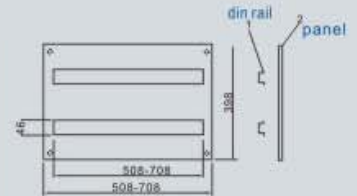
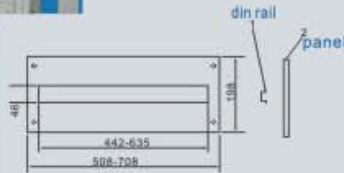

Flush panel

	Ref	Description	Pcs	Model
600	Panel 1x25P			MDP02 102F
	1	Din rail	1	
	2	Panel	1	
800	Panel 1x36P			MDP02 202F
	1	Din rail	1	
	2	Panel	1	

Flush panel

	Ref	Description	Pcs	Model
600	Panel 2x25P			MDP02 104F
	1	Din rail	1	
	2	Panel	1	
800	Panel 3x36P			MDP02 204F
	1	Din rail	1	
	2	Panel	1	



Component pallet

Two type:max carrying ability 50KG max carrying ability 100KG
 Material: manufactured in 1.5mm sheet steel with holes(except MPH604N&MPH605N&MPH606N)

Component pallet

Max.weight	W × D (mm)	50KG Model	50KG Model	100KG Model
600	300 × 471	MPH 604	MPH604N	MPH 604F
	400 × 471	MPH 605	MPH605N	MPH 605F
	500 × 471	MPH 606	MPH606N	MPH 606F
	300 × 671	MPH 804	MPH 804F	
800	400 × 671	MPH 805	MPH 805F	
	500 × 671	MPH 806	MPH 806F	

HH rail for component pallet



Model	Height(mm)
HH1400	1400mm
HH1600	1600mm
HH1800	1800mm
HH2000	2000mm
HH2200	2200mm

Accessories of floor stand cabinet

WD rail, WW rail with mounting flange

Pack: 4pcs/set with 5 rows of universal skeletal structures of partial assembly.
Manufactured in 1.5mm zinc passivated sheet steel with 8pcs fixing screws M513mm

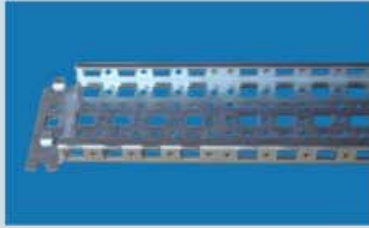

Model	For depth of cabinet(mm)			
	WD400	WD500	WD600	WD800
Dimension	400	500	600	800
Pcs/set	4	4	4	4
Model	WW600	WW800	WW1000	WW1200
	Dimension	600	800	1000
Pcs/set	4	4	4	4

Door rail

manufactured from 1.5mm sheet steel
pack: 1pcs door rail with fixing accessories



Perforated WHD rail

Rail 23x23mm model: WHD
Using angle bracket WHD001 install on the enclosure

Supply include:
1set(1pcs left bracket, 1pcs right bracket,
2pcs screws BZ5.5x13), angle bracket WHD001

Model	for cabinet width(mm)	Single or Double door
WA470	600	single
WA670	800	single
WA870	1000	single
WA270	800	double
WA370	1000	double

MODEL	WHD 400 (mm)	WHD 500 (mm)	WHD 600 (mm)	WHD 800 (mm)	WHD 1000 (mm)	WHD 1200 (mm)	WHD 1600 (mm)	WHD 1800 (mm)	WHD 2000 (mm)	WHD 2200 (mm)
LEGHT	295	395	495	695	895	1095	1495	1695	1895	2095
W H D	400	500	600	800	1000	1200	1600	1800	2000	2200
PCS/SET	12	12	12	12	12	12	6	6	6	6

UW rail



UW rail to be fixed on the cabinets width from 400mm-1200mm for replacement of mounting plate to hold electronic components
Material: galvanised steel sheet 2.5mm thickness
supply include: UW rails with fixing material

Model	For cabinet width(mm)	UW rail width (mm)
UW400	400	75
UW500	500	75
UW600	600	75
UW800	800	75
UW1000	1000	75
UW1200	1200	75

PC drawer(customized)



This is for special designed PC drawer, to be ordered to the clients special size

Computer pallet frame



It is easy to turn down in maintaining and return between door frame after maintained.
Carrying capacity: 30KG largest

Model	W	D	Cabinet width (mm)
C44	413	400	600
C64	613	400	800



Accessories of floor stand cabinet



Steel plan pocket

Color:RAL2008 thickness:1.5mm steel

For cabinet Width(mm)	Model	Size (mm)		
		W	H	D
400	PP400	255	260	90
500	PP500	355	260	90
600	PP600	455	260	90
800	PP800	655	260	90
900	PP900	755	260	90
1000	PP1000	855	260	90

A4 plastic plan pocket

Model:PP100 Material:ABS



Side cover

Material:sheet steel in 1.5mm
Color:RAL7032 or RAL7035
Supply :2pcs side covers & its fixing accessories
Function:connect into a complete cabinet

Model	Height (mm)	Depth (mm)
ARSP 124	1200	400
ARSP 126	1200	600
ARSP 128	1200	800
ARSP 144	1400	400
ARSP 146	1400	600
ARSP 148	1400	800
ARSP 166	1600	600
ARSP 168	1600	800
ARSP 184	1800	400

Model	Height (mm)	Depth (mm)
ARSP 185	1800	500
ARSP 186	1800	600
ARSP 188	1800	800
ARSP 204	2000	400
ARSP 205	2000	500
ARSP 206	2000	600
ARSP 208	2000	800
ARSP 226	2200	600
ARSP 228	2200	800

more size to be request to the clients...

AR8000/AR9000 plinth

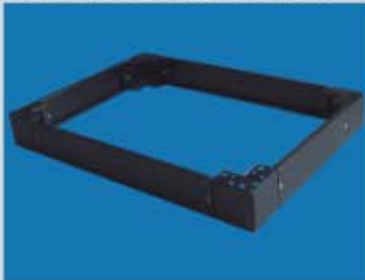

Standard plinth:H=100mm, H=200mm
plinth is made up of 2.5mm cold steel roll sheet
paint finish epoxy polyester powder coating textured finish. Color:RAL6022

Model		Cabinet size(mm)	
H100	H200	Width	Depth
PL1 35	PL2 35	300	500
PL1 36	PL2 36	300	600
PL1 38	PL2 38	300	800
PL1 45	PL2 45	400	500
PL1 46	PL2 46	400	600
PL1 64	PL2 64	600	400
PL1 65	PL2 65	600	500
PL1 66	PL2 66	600	600

Model		Cabinet size(mm)	
H100	H200	Width	Depth
PI1 86	PI2 86	800	600
PL1 88	PL2 88	800	800
PL1 104	PL2 104	1000	400
PL1 105	PL2 105	1000	500
PL1 106	PL2 106	1000	600
PL1 108	PL2 108	1000	800
PL1 124	PL2 124	1200	400
PL1 125	PL2 125	1200	500

Sealing rubber strip

Model:RUB001 pack:10metro/roll
Width:15mm



WA 065 ring



model: WA065
pack:4pcs/set

Special nut
model:SN-M6 or SN-M8
pack:50pcs/bag

Self tapping screw



Used for cabinet profiles,
punching rail and punching
material 4.5 mm round hole
Size:M5 X 10
Pack:100pcs/set

130° Hinge
model:TJ-CH130
pack:6pcs/set

Door stop

Model: DS001
Always keep the door open state
package:1 piece



Door stop

Model: WA100
For heavy equipment installation,
close the door when the door to
lift the ancillary equipment
Package: 1 piece



Insert nut

Model: WA6 WA8
Special designed nut use to install
on AR9000 manufactured from zinc
Alloy.
Package:50pcs/set



Accessories of floor stand cabinet



Fan and filter

ABS synthetic resin, fire resistant and UV-resistant, dustproof coefficient: 80%.

Fan

Model	The outer part	Voltage	Current	Air flow
KA1238HA2B	120×120×38mm	220~240VAC	0.13/0.11A	120/140CFM
KA1725HA2B	φ172×55mm	220~240VAC	0.13/0.12A	218/245CFM
KA2206HA2B-2P	φ220×60mm	220~240VAC	0.25/0.18A	430/490CFM
KA2509HA2B-2P	φ254×89mm	220~240VAC	0.28/0.22A	666/730CFM

Filter

Model	The outer part	Efficient blast volume	level of protection	Applicable blower fan
FU-9803A	148.5×148.5×13.5mm	25.0m ³ /min	IP44	KA1238HA2B
FU-9804A	204×204×13.5mm	50.0m ³ /min	IP44	KA1725HA2B
FU-9805A	255×255×13.5mm	80.0m ³ /min	IP44	KA2206HA2B-2P
FU-9806A	320×320×13.5mm	120m ³ /min	IP44	KA2509HA2B-2P

Divide plate

Divide plate is made up of 1.5mm sheet steel with fixing accessories, using HH rails, WD rails to hold divide plate



MODEL	cabinet width	W x H (mm)
MP 64	600	492X333
MP 82	800	692X133
MP 86	800	692X533
MP 104	1000	892X333
MP 106	1000	892X533
MP 122	1200	1092X133
MP 124	1200	1092X333
MP 126	1200	1092X533

WI300 ring

Model: WI300

4pcs/set with fixing accessories



Baying bracket

Model: WA020

For connection and hanger two devices.

Material: sheet zinc-plating.

Package: 4pcs/set



Baying bracket

Model: WA030

For connection and hanger two devices.

Material: sheet zinc-plating

Package: 1pcs/set



Steel bolt anchor

Model: WA010

Hexagon steel proximate matter, supply include: its fixing accessories zinc-plating package: 6pcs/set



Lock MS 830

1pcs/set with lock system, key and fixing accessories



Lock MS 821

1pcs/set with lock system, key and fixing accessories





Innovation

Other special requested in size, technical processing, color and locking system can provide according to your requirement



Industrial Cabinets

perfect solution tailored just for you

Steel wall mount enclosure



Single door wall mount enclosure

Supply Include:

Enclosure and door ,mounting plate, lock system, gland plate, sealing gasket and fixing accessories.

Standard Configuration

Paint finish epoxy polyester powder coating textured finish

Color: RAL 7032 or RAL 7035

Protection degree:IP 66

Against mechanical impacts: IK 10

Thickness:

Enclosure & door: sheet steel 1.2mm till size
ST6 820 then 1.5mm.

Mounting p late:

zinc-coated steel 1.5mm till size ST6 820 then 2.0mm

CONFORMITY AND APPROVAL

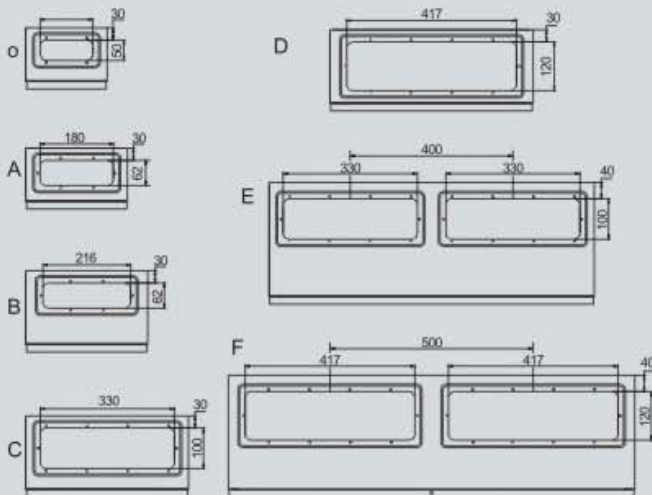

Mounting plate for wall mount enclosure

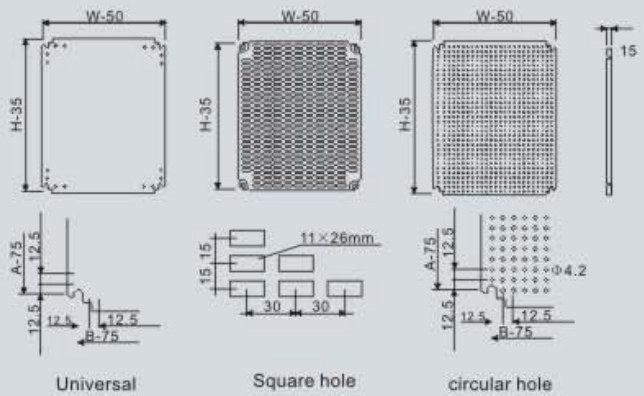

Note: door hinges on the left for the left open door,
door hinges on the right for the right open door

Selection Table

Model	W	H	D	No.of lock	Gland open
ST2 215	200	200	150	1	O
ST2 2515	200	250	150	1	O
ST25 2515	250	250	150	1	A
ST2 315	200	300	150	1	O
ST25 315	250	300	150	1	A
ST3 315	300	300	150	1	B
ST4 315	400	300	150	1	B
ST3 415	300	400	150	1	B
ST4 415	400	400	150	1	B
ST3 515	300	500	150	1	B
ST4 515	400	500	150	1	B
ST5 615	500	500	150	1	D
ST4 615	400	600	150	2	C
ST5 615	500	600	150	2	D
ST25 320	250	300	200	1	A
ST3 320	300	300	200	1	B
ST4 320	400	300	200	1	B
ST3 420	300	400	200	1	B
ST4 420	400	400	200	1	B
ST6 420	600	400	200	1	D
ST3 520	300	500	200	1	B
ST4 520	400	500	200	1	B

Model	W	H	D	No.of lock	Gland open
ST5 520	500	500	200	1	D
ST4 620	400	600	200	2	C
ST5 620	500	600	200	2	D
ST6 620	600	600	200	2	D
ST5 720	500	700	200	2	D
ST6 720	600	700	200	2	D
ST6 820	600	800	200	2	D
ST8 820	800	800	200	2	E
ST6 1020	600	1000	200	3	D
ST8 1020	800	1000	200	3	E
ST6 1220	600	1200	200	3	D
ST8 1220	800	1200	200	3	E
ST4 425	400	400	250	2	C
ST6 425	600	400	250	1	D
ST4 525	400	500	250	1	C
ST5 525	500	500	250	2	D
ST4 625	400	600	250	2	C
ST5 625	500	600	250	2	D
ST6 625	600	600	250	2	D
ST5 725	500	700	250	2	D
ST6 825	600	800	250	2	D
ST8 825	800	800	250	2	E

Model	W	H	D	No.of lock	Gland open
ST6 1025	600	1000	250	3	D
ST8 1025	800	1000	250	3	E
ST6 1225	600	1200	250	3	D
ST8 1225	800	1200	250	3	E
ST4 530	400	500	300	2	C
ST4 630	400	600	300	2	C
ST5 630	500	600	300	2	D
ST6 630	600	600	300	2	D
ST5 730	500	700	300	2	D
ST6 830	600	800	300	2	D
ST8 830	800	800	300	2	E
ST6 1030	600	1000	300	3	D
ST6 1230	600	1200	300	3	D
ST8 1030	800	1000	300	3	E
ST8 1230	800	1200	300	3	E
ST8 1430	800	1400	300	3	E
ST6 840	600	800	400	2	D
ST8 840	800	800	400	2	E
ST6 1040	600	1000	400	3	D
ST8 1040	800	1000	400	3	E
ST6 1240	600	1200	400	3	D
ST8 1240	800	1200	400	3	E
ST8 1440	800	1400	400	3	E

more size to be request to the clients...



Double door wall mount enclosure



Double door wall mount enclosure

Supply Include

Enclosure and door with lock system, galvanised mounting plate, gland plate, sealing gasket and fixing accessories.

Standard Configuration

Paint finish epoxy polyester powder coating textured finish

Color: RAL 7032 or RAL 7035

Protection degree: IP 55

Against mechanical impacts: IK 10

Thickness:

Enclosure & door: sheet steel 1.5mm.

Mounting plate:

Galvanised sheet steel :2.0mm

CONFORMITY AND APPROVAL



STD double door enclosure with standard lock K2

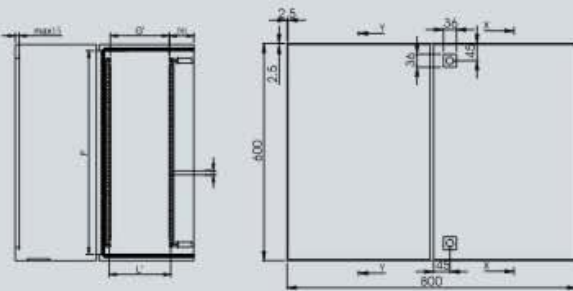

STD(standard lock K2)

Model	W	H	D	No. of lock	Gland open
STD8 620	800	600	200	2	E
STD8 625	800	600	250	2	E
STD8 630	800	600	300	2	E
STD8 640	800	600	400	2	E
STD10 620	1000	600	200	2	E
STD10 625	1000	600	250	2	E
STD10 630	1000	600	300	2	E
STD10 640	1000	600	400	2	E
STD12 620	1200	600	200	2	E
STD12 625	1200	600	250	2	E
STD12 630	1200	600	300	2	E
STD12 640	1200	600	400	2	E
STD8 820	800	800	200	2	F
STD8 825	800	800	250	2	F
STD8 830	800	800	300	2	F
STD8 840	800	800	400	2	F
STD10 820	1000	800	200	2	F
STD10 825	1000	800	250	2	F
STD10 830	1000	800	300	2	F
STD10 840	1000	800	400	2	F
STD12 820	1200	800	200	2	F
STD12 825	1200	800	250	2	F
STD12 830	1200	800	300	2	F
STD12 840	1200	800	400	2	F
STD10 1020	1000	1000	200	2	F
STD10 1025	1000	1000	250	2	F
STD10 1030	1000	1000	300	2	F
STD10 1040	1000	1000	400	2	F
STD12 1020	1200	1000	200	2	F
STD12 1025	1200	1000	250	2	F
STD12 1030	1200	1000	300	2	F
STD12 1040	1200	1000	400	2	F
STD10 1220	1000	1200	200	2	F
STD10 1225	1000	1200	250	2	F
STD10 1230	1000	1200	300	2	F
STD10 1240	1000	1200	400	2	F

more size to be request to the clients...

STDD(Rod Centre lock) with lock MS821

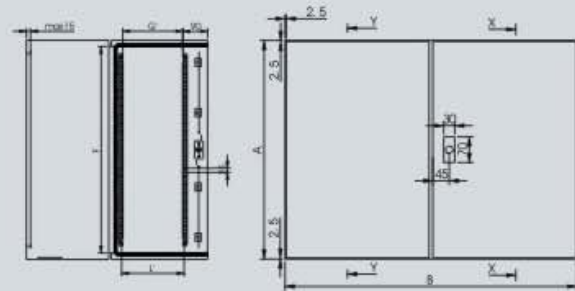

STDD(Rod Centre lock) with lock MS821

Model	W	H	D	No. of lock	Gland open
STDD8 620	800	600	200	1	E
STDD8 625	800	600	250	1	E
STDD8 630	800	600	300	1	E
STDD8 640	800	600	400	1	E
STDD10 620	1000	600	200	1	E
STDD10 625	1000	600	250	1	E
STDD10 630	1000	600	300	1	E
STDD10 640	1000	600	400	1	E
STDD12 620	1200	600	200	1	E
STDD12 625	1200	600	250	1	E
STDD12 630	1200	600	300	1	E
STDD12 640	1200	600	400	1	E
STDD8 820	800	800	200	1	F
STDD8 825	800	800	250	1	F
STDD8 830	800	800	300	1	F
STDD8 840	800	800	400	1	F
STDD10 820	1000	800	200	1	F
STDD10 825	1000	800	250	1	F
STDD10 830	1000	800	300	1	F
STDD10 840	1000	800	400	1	F
STDD12 820	1200	800	200	1	F
STDD12 825	1200	800	250	1	F
STDD12 830	1200	800	300	1	F
STDD12 840	1200	800	400	1	F
STDD10 1020	1000	1000	200	1	F
STDD10 1025	1000	1000	250	1	F
STDD10 1030	1000	1000	300	1	F
STDD10 1040	1000	1000	400	1	F
STDD12 1020	1200	1000	200	1	F
STDD12 1025	1200	1000	250	1	F
STDD12 1030	1200	1000	300	1	F
STDD12 1040	1200	1000	400	1	F
STDD10 1220	1000	1200	200	1	F
STDD10 1225	1000	1200	250	1	F
STDD10 1230	1000	1200	300	1	F
STDD10 1240	1000	1200	400	1	F

Plexiglass door wall mount enclosure

Inner door wall mount enclosure

Modular kit for wall mount enclosure

Plexiglass door-inner door wall mount enclosure

Color: RAL 7032 or RAL 7035, paint finish epoxy polyester powder coating textured finish

Protection degree: IP 66

Against mechanical impacts: IK10

Enclosure & door & inner door: sheet steel 1.2mm till size ST6 820 then 1.5mm, mounting plate: zinc-coated steel 1.5mm till size ST6 820 then 2.0mm, plexiglass door 4.0mm



Plexiglass door wall mount enclosure (STP)

Supply include: enclosure, door with plexiglass & lock system, mounting plate, gland plate, sealing gasket and fixing accessories.



Inner door wall mount enclosure (STI)

Supply include: enclosure, door with lock system, inner door with lock systems, mounting plate, gland plate, sealing gasket and fixing accessories.



Plexiglass door + inner door wall mount enclosure (STIP)

Supply include: enclosure, outer door with plexiglass & lock system, inner door with lock systems, mounting plate, gland plate, sealing gasket and fixing accessories.

Model	Model	Model	W × H × D(mm)	No. of lock
STP2 315	STI2 315	STIP2 315	200×300×150	1
STP3 415	STI3 415	STIP3 415	300×400×150	1
STP3 420	STI3 420	STIP3 420	300×400×200	1
STP4 315	STI4 315	STIP4 315	400×300×150	1
STP4 420	STI4 420	STIP4 420	400×400×200	1
STP4 520	STI4 520	STIP4 520	400×500×200	1
STP4 620	STI4 620	STIP4 620	400×600×200	2
STP5 520	STI5 520	STIP5 520	500×500×200	1
STP5 725	STI5 725	STIP5 725	500×700×250	2
STP6 420	STI6 420	STIP6 420	600×400×200	2

Model	Model	Model	W × H × D(mm)	No. of lock
STP6 620	STI6 620	STIP6 620	600×600×200	2
STP6 625	STI6 625	STIP6 625	600×600×250	2
STP6 630	STI6 630	STIP6 630	600×600×300	2
STP6 820	STI6 820	STIP6 820	600×800×200	2
STP6 825	STI6 825	STIP6 825	600×800×250	2
STP6 830	STI6 830	STIP6 830	600×800×300	2
STP6 1230	STI6 1230	STIP6 1230	600×1200×300	3
STP8 830	STI8 830	STIP8 830	800×800×300	3
STP8 1030	STI8 1030	STIP8 1030	800×1000×300	3
STP8 1230	STI8 1230	STIP8 1230	800×1200×300	3

more size to be request to the client...

Modular kit for steel wall mount box



MODEL	DOOR (mm)		No. of breakers	Breakers qty PCS(mm)	No. of rows (mm)
	W	H			
MDST43	300	400	2rows × 9P	18	2
MDST54	400	500	3rows × 15P	45	3
MDST64	400	600	3rows × 15P	45	3
MDST66	600	600	3rows × 26P	78	3
MDST75	500	700	3rows × 21P	60	4
MDST75R	500	700	4rows × 21P	80	4
MDST86	600	800	3rows × 26P	78	4
MDST86R	600	800	4rows × 26P	104	4
MDST106	600	1000	6rows × 26P	158	6
MDST108	800	1000	6rows × 38P	222	6

more size to be request to the client...

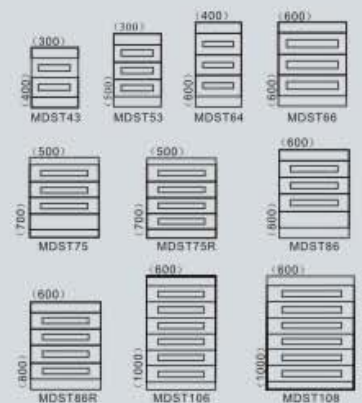

Special box(customized enclosure) MCB box/Gland box/Telephone box

MCB box

AS & AE series boxes are TIBOX specially designs for MCBs.This kind of surface & flush mounting boxes can assemble 16P & 24P MCBs each row, or adjust by your own.Material: Sheet steel 1.2mm
Protection degree: IP54
Surface finish: epoxy polyester powder coating textured finish
Color: RAL 7035

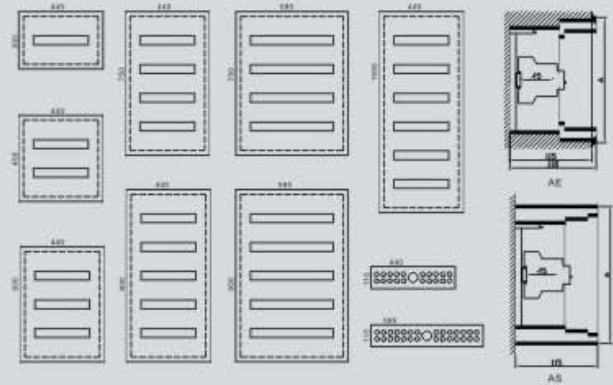

MCB box

Surface type	DOOR(mm)		1 ROW	NO.of breakers
	W	H		
AS1 16	440	300	1	×16P
AS2 16	440	450	2	×16P
AS3 16	440	600	3	×16P
AS4 16	440	750	4	×16P
AS5 16	440	900	5	×16P
AS6 16	440	1050	6	×16P
AS7 16	585	750	4	×24P
AS8 16	585	900	5	×24P

Flush type	DOOR(mm)		1 ROW	NO.of breakers
	W	H		
AE116	465	325	1	×16P
AE216	465	475	2	×16P
AE316	465	625	3	×16P
AE416	465	775	4	×16P
AE516	465	925	5	×16P
AE616	465	1075	6	×16P
AE716	610	775	4	×24P
AE816	610	925	5	×24P



Telephone enclosure

TE enclosure are designed to standard telephone connectors used for domestic and commercial applicateion.Flush or surface mounting boxes conforming to IP41.Madeout of high quality steel sheet,knock-outs provided on all sides adjustable zincmouning plate,with cam key lock Color: RAL 7035

Descripton	W(mm)	H(mm)	D(mm)	CONNECTION PAIRS	Cat.no
Surface Type	230	230	100	10 TO 40	TE2323
Flush type	230	230	100	10 TO 60	TEF2323
Surface Type	330	300	100	10 TO 70	TE3033
Flush type	330	300	100	10 TO 80	ETF3033
Surface Type	520	370	100	10 TO 140	TE3752
Flush type	520	370	100	10 TO 160	TEF3752
Surface Type	620	520	100	10 TO 420	TE5262

Telephone enclosure

Gland box

GB series box can be used as the gland box of the ST wall mount enclosure, Material:sheet steel 1.2mm ,surface finish:epoxy polyester powder coating textured finish Color:RAL7035 or RAL 7032



Gland box

Model	Size(mm)		
	W	H	D
GB432	300	400	200
GB532	300	500	200
GB632	300	600	200
GB8325	300	800	250
GB4252	250	400	200
GB5252	250	500	200
GB6252	250	600	200
GB82525	250	800	250
GB422	200	400	200
GB522	200	500	200
GB1033	300	1000	300

Steel terminal box



TL-G series - with gland hole

Supply Include: Enclosure & cover (sheet steel 1.2mm), sealing gasket and fixing accessories, Gland holes & gland plates
 Paint finish: epoxy polyester powder coating textured finish Color: RAL7032 or RAL7035
 Protection degree: IP66 Against mechanical impacts: IK10
 galvanised mounting plate to be supplied separately, see Page 09...

Model	W H D
TL301512-G	300×150×120
TL302012-G	300×200×120
TL303012-G	300×300×120
TL402012-G	400×200×120
TL404012-G	400×400×120
TL502012-G	500×200×120

Model	W H D
TL503012-G	500×300×120
TL602012-G	600×200×120
TL603012-G	600×300×120
TL604012-G	600×400×120
TL802012-G	800×200×120
TL804012-G	800×400×120

more size to be request to the clients...



TL series - No gland hole

Supply Include: Enclosure & cover (sheet steel 1.2mm), sealing gasket and fixing accessories,
 Paint finish: epoxy polyester powder coating textured finish Color: RAL7032 or RAL7035
 Protection degree: IP66 Against mechanical impacts: IK10
 galvanised mounting plate to be supplied separately, see Page 09...

Model	W H D
TL15158	150×150×80
TL151512	150×150×120
TL201512	200×150×120
TL20208	200×200×80
TL30158	300×150×80
TL301512	300×150×120

Model	W H D
TL30208	300×200×80
TL302012	300×200×120
TL401512	400×150×120
TL40208	400×200×80
TL403012	400×300×120
TL404012	400×400×120

Model	W H D
TL502012	500×200×120
TL503012	500×300×120
TL602012	600×200×120
TL603012	600×300×120
TL802012	800×200×120
TL804012	800×400×120

more size to be request to the clients...



TB series 180° hinges with lock system

Supply Include: Enclosure with gland holes, cover with sealing gasket and fixing accessories,
 lock system Paint finish: epoxy polyester powder coating textured finish.
 Color: RAL7032 or RAL7035 Protection degree: IP66 Against mechanical impacts: IK10
 galvanised mounting plate to be supplied separately, see Page 09...

Model	W H D
TB15158	150×150×80
TB15308	150×300×80
TB20208	200×200×80
TB20308	200×300×80
TB20408	200×400×80
TB151512	150×150×120
TB153012	150×300×120
TB202012	200×200×120

Model	W H D
TB203012	200×300×120
TB204012	200×400×120
TB205012	200×500×120
TB303012	300×300×120
TB304012	300×400×120
TB3040155	300×400×155
TB3060155	300×600×155
TB3080155	300×800×155

more size to be request to the clients...



TBS series 180° hinges with hinges

Supply Include: Enclosure with gland holes, cover with sealing gasket and fixing accessories
 Paint finish: epoxy polyester powder coating textured finish. Color: RAL7032 or RAL7035
 Protection degree: IP66 Against mechanical impacts: IK10
 galvanised mounting plate to be supplied separately, see Page 09...

Model	W H D
TBS15158	150×150×80
TBS15308	150×300×80
TBS20208	200×200×80
TBS20308	200×300×80
TBS20408	200×400×80

Model	W H D
TBS151512	150×150×120
TBS153012	150×300×120
TBS202012	200×200×120
TBS203012	200×300×120
TBS204012	200×400×120

Model	W H D
TBS205012	200×500×120
TBS303012	300×300×120
TBS304012	300×400×120
TBS3040155	300×400×155
TBS3060155	300×600×155

more size to be request to the clients...



Accessories of wall mount enclosure

Metal lock



LK-5



Lock transformations to zinc alloy insert triangle and square options

Rain-proof cover for lock



TK-5-A

WP001

Locks



K1



K2



K3



MS820



MS407



K4



LS-1



MS738

100mm high plinth can be used for ST boxes.
Material: sheet steel Color: RAL 6022

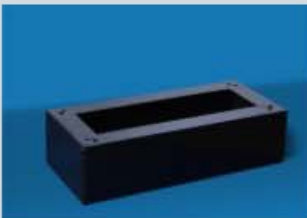

Plinth



Plinth for wall mount enclosure

Model	Cabinet size(mm)		Model	Cabinet size(mm)	
	W	D		W	D
TT42	400	200	TT43	400	300
TT52	500	200	TT53	500	300
TT62	600	200	TT63	600	300
TT82	800	200	TT83	800	300
TT102	1000	200	TT103	1000	300
TT122	1200	200	TT123	1200	300



Earth wire



Earth wire for enclosure

Model	S(mm ²)	Length(mm)	Diameter of rings(mm)
TJ-CM6130	6	130	6.4
TJ-CM6160	6	160	6.4
TJ-CM6168	6	160	8.3
TJ-CM1025	10	250	6.4
TJ-CM2535	25	350	8.3



Plastic cover for MCB box



Model: MC09
MC18

molded plastic cover to be used in MCB enclosure to cover the holes, to avoid dust and water inside the MCB enclosure

MC09 9mm long 1/2P

MC18 18mm long 1P

Accessories of wall mount enclosure



Canopy



more size to be request to the clients...

Canopy (roof)

Model	For box size(mm)	
	W	D
TT1 03	300	150
TT2 03	300	200
TT0 04	400	150
TT1 04	400	200
TT2 04	400	250
TT3 04	400	300
TT0 05	500	150
TT1 05	500	200
TT2 05	500	250

Model	For box size(mm)	
	W	D
TT3 05	500	300
TT0 06	600	200
TT1 06	600	250
TT2 06	600	300
TT3 06	600	400
TT0 08	800	200
TT1 08	800	250
TT2 08	800	300
TT3 08	800	400

Recommended for outdoor installation.-Manufactured in 1.2mm sheet steel.

Surface finish: TIBOX standard cycle thermosetting epoxy polyester powder coating in textured for outdoor installation. we suggest a specific painting Color: RAL 7032 or RAL 7035



Door rail



Door rail (crosspiece for door)

Mod.	Code		Width(mm)
	Art	Box	
WC	001	300	
WC	002	400	
WC	003	500	
WC	004	600	
WC	005	800	

To be fixed on the vertical rail of the door to simplify fixing of cable ducts. Manufactured in 1.2mm sheet steel. Zinc plated passivated with 4.2mmdiameter holes punched in 25mm pinch patten.Pack: 1piece with fixing material



WA 060



Door stop

Holds the door at 90° to avoid accidental closing. Manufactured in 2mm and 3mm sheet steel zinc plated passivated can be used on ST boxes till size ST6 820.

Pack of 1 piece with fixing material

Model: WA 060



WA 070



Door stop

Holds the door at 90° to avoid accidental closing. Manufactured in 2mm and 3mm sheet steel zinc plated passivated can be used on ST boxes from ST6 820

Pack of 1 piece with fixing material

Model: WA 070



WA 080 upright post fixing

Model: WA 080

WA 080 can be used to fix the wall mount enclosure onto upright posts easily, the width of the boxes should be no more than 600mm

Material: sheet steel, galvanized steel

Packing: 2pcs/set per pack(include 4pcs nuts & bolts)



Accessories of wall mount enclosure



WC010



Wall mount bracket : WC 010

Manufactured in 4mm sheet steel zinc plated passivated.
Pack of 4 pieces with fixing material
Model: WC 010
For box model ST,STI,STIP,STIP wall mount enclosure



WTC010



Wall mount bracket: WTC 010

Manufactured in 4mm sheet steel zinc plated passivated
Pack of 4 pieces with fixing material
For the box model TB,TL,TBS,TL-G terminal box
Package:4pcs/set
Model: WTC 010

Louver plates(ventilation plate)

To be fitted on any surface of the enclosure for internal ventilation. Supply include 1 piece louver plate & fixing material,gasket Colour RAL7032 textured finish

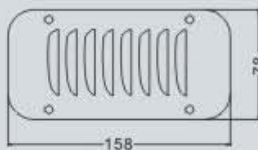

Model: GP-O

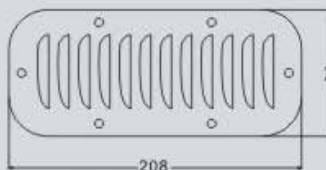

Model: GP-A

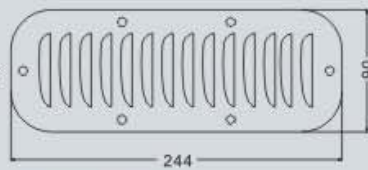

Model: GP-B

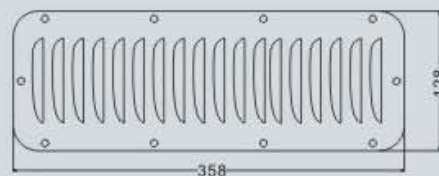

Model: GP-C

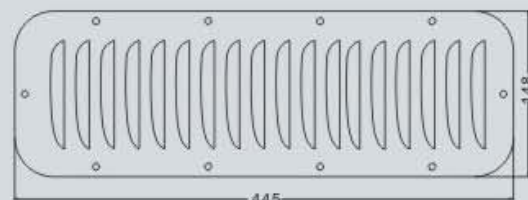

Model: GP-D

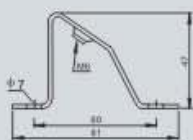

WL02 45° bracket

WL 02 brackets can be used to slope the DIN rails into 45,
1 pack of 20 pieces
Model: WL 020

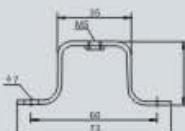

WS02 bracket

WS 02 brackets can be used to upraise the DIN rails,
1 pack of 20 pieces
Model: WS 02

Complete equipment

MNS Low-voltage withdrawable complete switchgear equipment

ST series of low-enclosed control box



MNS Low-voltage withdrawable complete switchgear equipment

Introduction

1. MNS is a modular, multi-purpose low-voltage distribution cabinet. Used in metallurgy, petroleum, chemical, industrial and mining enterprises and infrastructure for all occasions that require high reliability low pressure systems, power distribution and motor control systems.
2. MNS using specific high degree flexibility of cabinet structure. According to customer needs or different occasions, the cabinet can be mounted a variety of models and specifications of components. According to different electrical equipments, Various types of feed units can be mounted in a series of cabinet or a cabinet. Such as: feeder circuits and motor control circuits can be mixed together.
3. MNS is a full range of low voltage switchgear, meet your full range of needs. Used for 1200 A low pressure system.
4. MNS can provide a high level of reliability and security. User-friendly design, enhanced safety for personnel and equipment needed for protection.
5. MNS for the whole assembly structure, Its unique profiles structure and connection and compatibility of the various components
6. Standard: IEC60439.1, GB7251.1

Main features

1. In order to facilitate the installation and on-site construction of equipment no dedicated cable channel in the distribution cabinet, along with the appropriate cable fasteners.
2. Special profile structural and connections to ensure strength of the cabinet.
3. Various locations of drawer unit can positioning accuracy, clear instructions, and can be locked in each position separately.
4. Standardization profiles and universal connector can be assembled without limitation.

Ordering Notice: Please provide the following information

1. All models products include the main circuit number and auxiliary circuit scheme number.
2. Main circuit system sequence diagram
3. Cabinet floor plan
4. Auxiliary circuit electrical schematics
5. Components list inside cabinet
6. voltage, current and time setting parameters in Circuit
7. It is incompatible with the normal use of the product other special requirements



ST series of low-enclosed control box

Introduction

ST series of closed-end distribution box suitable for 50Hz, 660V and below, the load current less than 225A three-phase three-wire, three-phase four-wire, three-phase five-wire system, the distribution system for control, leakage protection and motor overload, short circuit, lack of protection and various control, the box has rational design, small size, beautiful appearance, safe and reliable, widely used in metallurgy, petrochemical, health care, aviation, residential areas, shopping malls, schools, urban renewal, etc.

Ordering Notice: Please specify when ordering

1. Model
2. Installation
3. Structure
4. System Diagram
5. Special requirements can be resolved through consultation Cabinet color (if not indicated, according to the standard color RAL7032)



Complete equipment MCC motor control center



MCC motor control center

Introduction

MOTOR CONTROL CENTER, abbreviation MCC. Motor control centers will unified management of power distribution equipment, will be loaded into a variety of motor control unit, a joint unit feeders, distribution transformers, lighting distribution panels, interlocking relays and metering equipment installed within the cabinet as a whole and by one common enclosed bus powered.

In all areas of the national economy, such as electricity, petroleum, chemical, metallurgy, mining, paper, light industry, automobile, shipbuilding industry, transportation, municipal construction, food and beverage, water treatment, waste disposal, pharmaceutical, motor get more to the more widely used. To make the motor running and reliable operation, the need for a single motor and a unified production line motor control and protection.

Therefore, the level of motor control center MCC has also been developing rapidly. MCC aims to be connected to AC low voltage circuit full motor control and protection equipment, according to certain specifications of the system components assembled into standardized units corresponding specifications of each component controls a motor, this standard cell assemblies loaded into the cabinet to achieve multiple centralized control of the motor.

Suitable Environment

Working temperature: $-10^{\circ}\text{C} \sim +55^{\circ}\text{C}$
Storage temperature: $-20^{\circ}\text{C} \sim +65^{\circ}\text{C}$
Relative humidity: 5% ~ 95%
No frost Altitude: $\leq 2500\text{m}$
Pollution degree: 2
Protection degree: Ip20
Installation Level: 111
Use the occasion: coal, petrochemical, metallurgy, electric power, shipbuilding, and civil construction and other fields.

MCC Superiority motor control center

Using MCC (MOTOR CONTROL CENTER) specialized intelligent management programs, in addition to all the advantages of remote monitoring mode, also reduce the amount of isolation devices, terminal block (box), I/O cards, analog transmitters and so on. And smart devices installed locally, connect with the host computer via a communication line, you can save a lot of control cables, saving a lot of investment and effort to install and maintain, thereby reducing costs. In addition, the function of each device is relatively independent, only connected through the network between the devices, network configuration and flexible

so that a reliable line of the whole system is greatly improved, any device failure affects only the corresponding components will not cause the system to crash. This distributed control system and centralized management of the combined model, its more powerful, with better security, is the main trend of the current metallurgical steel industry electrical automation control.

Ordering Notice: Please provide the following information when ordering.
Model Specifications Quantity
Primary circuit program Color (if not required, according to our standard color RAL7032) Other special requirements



Transmisiones Ltda. Carrera 68 B # 21 A -
 24, bodega UE 28- 1 Parque Industrial
 Montevideo PBX: (57+1) 4126898
 Bogotá - Colombia
 info@ transmisiones.de
 www.transmisiones.de



ZHEJIANG TIANQI ELECTRIC CO.,LTD.



Polyester enclosure



Plastic enclosure



Terminal block box



Cable gland



Aluminum enclosure



Stainless steel cabinet



Stainless steel box



Floor stand cabinet



Un-assembled cabinet



Control desk



Wall mount enclosure



Terminal box



MCB box



Accessories of box



Complete set

ZHEJIANG TIANQI ELECTRIC CO.,LTD.

Add: Tianzi Lake Industrial Zone, Gaoyu, Anji, Huzhou, Zhejiang, China
 TEL:+86-572-5815118 FAX:+86-572-5118861
 H.P.:(0)13355825666 P.C.:313310 Skype:marrywang14
 E-mail:marry@tibox.cn MSN:tjfirm@hotmail.com
 Website: Http://www.tibox.cn

版权所有 违者必究